

2 0 2 5

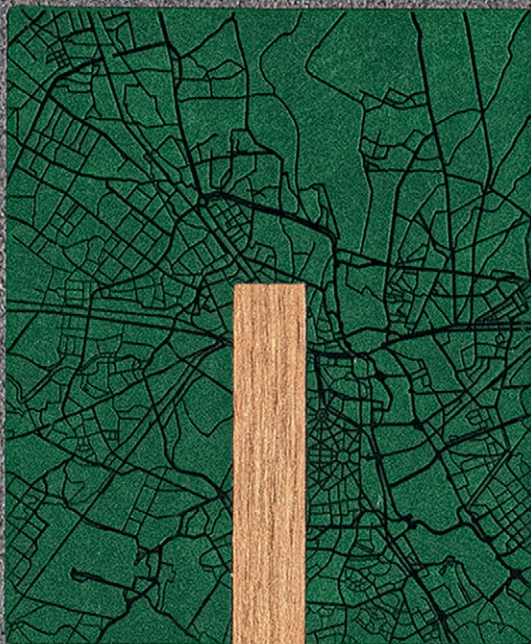



PAPIER Z KAMIENIA / stone paper



PAPIER Z TRAWY / grass paper



PAPIER Z RECYKLINGU / recycled paper

WZORY PAPIERÓW EKOLOGICZNYCH PREZENTUJEMY NA KOŃCU KATALOGU.

Samples of ecological papers are presented at the end of the catalogue.

SPIS TREŚCI / table of contents

DRZEWO ZA KALENDARZ / tree for a calendar	04	METALLIC PRINT	64
N1 NASIONA SOSNY / pine seeds	06	IDEO	66
PAPIER Z NASIONAMI / paper with seeds	08	IDEO EXCLUSIVE	68
METODY ZNAKOWANIA / marking methods	10	CARBON / LUNGO ^{NEW}	70
ZNAKOWANIE OPRAW / cover marking methods	11	ITALIANO	72
SENSO ^{NEW}	14	KALENDARZE BIURKOWE / desk calendars	76
LAVA ^{NEW}	16	KALENDARZE BIURKOWE / desk calendars ^{NEW}	78
LINO ^{NEW}	18	OPAKOWANIA / packaging	80
rPET	22	DODATKI / add-ons	82
COLORI ^{NEW}	24	PROJEKT AUTORSKI / customised design	93
AUTORSKIE NAKLEJKI METALICZNE / personalised metallic stickers ^{NEW}	26	ŁĄCZENIE OPRAW / cover combinations	94
RE-COVER	28	TYPY OPRAW / types of cover	95
QUERK	30	PROPOZYCJE ROKÓW / year design propositions	96
SZYCIE KREATYWNE / creative stitching	32	MATRYCE / stamps	102
NATURA	34	UKŁADY KALENDARZY DZIENNYCH / daily calendar layouts	104
SAVANA	36	UKŁADY KALENDARZY TYGODNIOWYCH / weekly calendar layouts	110
GAMBO	38	UKŁAD PLANERA / planner layout	118
CROSS	40	UKŁAD KALENDARZA DWUDZIENNEGO / two-day calendar layout ^{NEW}	120
COLORADO	42	UKŁADY KALENDARZY BIURKOWYCH / desk calendar layouts ^{NEW}	122
PIKO	44	UKŁADY NOTESOWE / notebook layouts	124
FLESZ	44	ZESTAWIENIE BLOKÓW / overview of interior blocks	126
GUMA	46	GADŻETY ECO / eco gadgets	128
VIVELA	48	ROZGAŁĘŻNIKI USB / USB charging cables	136
TŁOCZENIA / debossings	52	POWERBANKI / powerbanks	137
CANVAS	54	ROZGAŁĘŻNIKI USB / USB charging cables	138
CANVAS LINE	56	POWER SET	140
CANVAS – SPINE / HORIZONT	58	ENERGY SET	141
STONEBOOK	60	POWER SET LONG	142
KRAFT	62	WHITE BOX & BLACK BOX	143
IMAGE	63	POWERBANK ^{NEW}	144

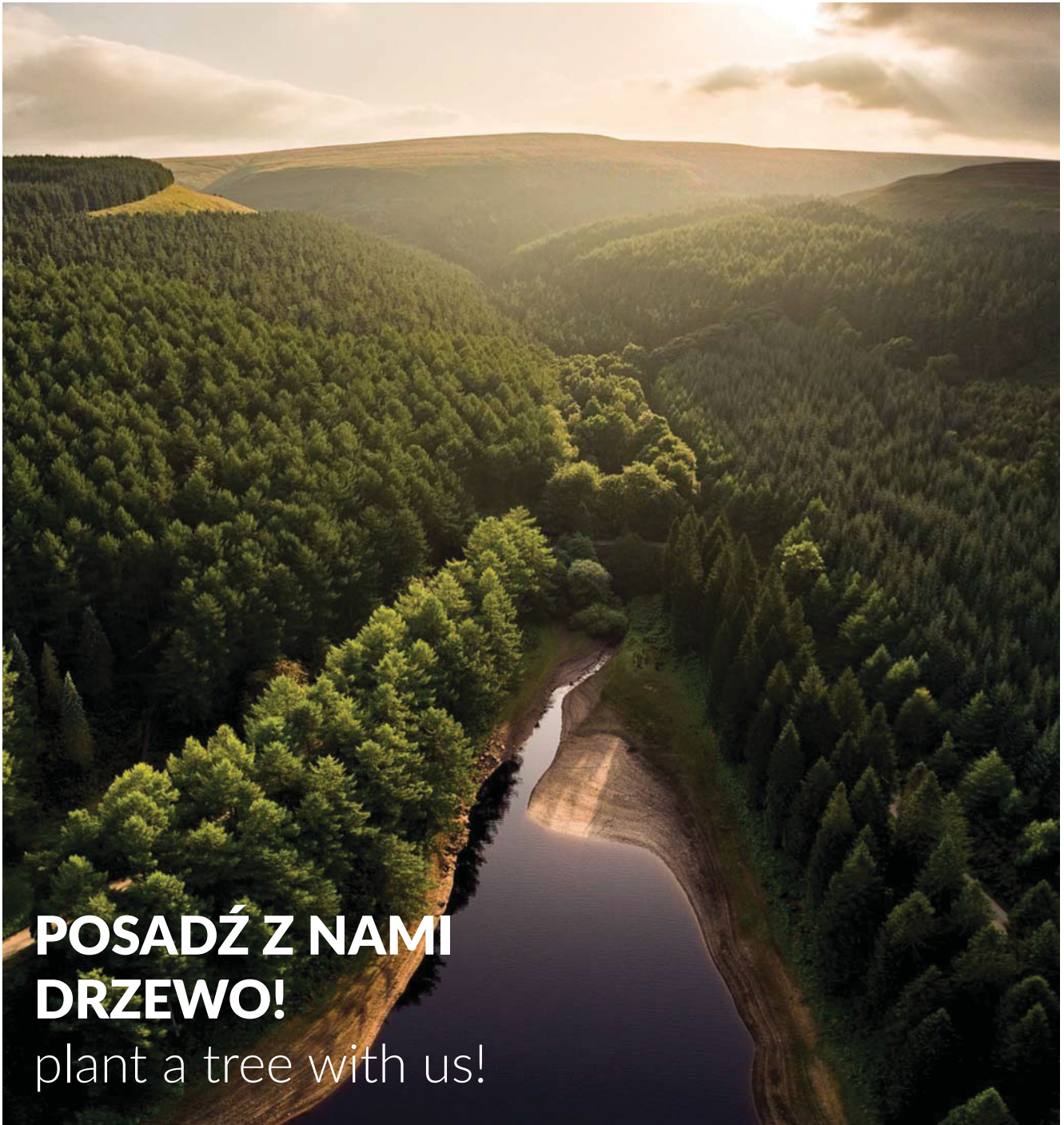

**POSADŹ Z NAMI
DRZEWO!**
plant a tree with us!

W 2023 ROKU WSPÓLNIE POSADZILIŚMY 6037 DRZEW

In 2023, we collectively planted 6037 trees

MIERZALNE EFEKTY / measurable effects:

4045 osób oddycha świeżym tlenem / 4045 people are able to breathe fresh oxygen

350 146 kg zwróconego papieru / 350 146 kg amount of paper returned

6 701 m² powierzchni lasu / 6 701 m² area of the forest

36 222 kg pochłanianego CO₂ na rok / 36 222 kg CO₂ absorption per year

**DZIĘKI PROGRAMOWI
POSADZIMY.PL
ZA KAŻDE ZAKUPIONE U NAS
100 KALENDARZY,
ZASADZIMY 1 DRZEWO.**

Thanks to posadzimy.pl campaign, for every 100 calendars purchased from us, we are going to plant 1 tree.

100 KALENDARZY /
CALENDARS



=

1 DRZEWO /
TREE





inspiracja / inspiration

rok / year design

7

oprawa / cover

SAVANA

znakowanie / marking method

druk UV / UV print

dodatek / add-on

N1

N1 NASIONA SOSNY / pine seeds



1

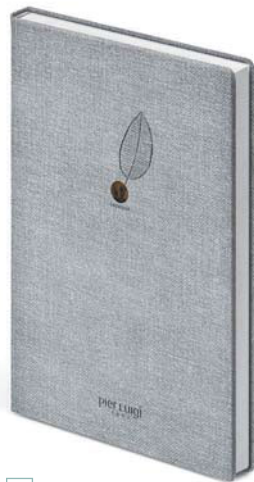

2



3



4



5

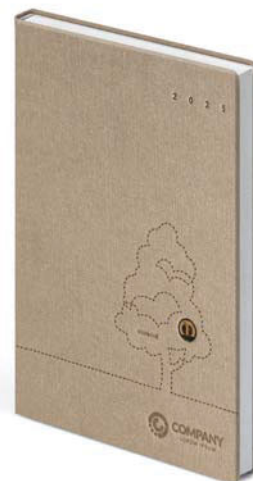

6

inspiracja / inspiration

rok / year design

4 - drukowany / printed, 5 - 1C, 6 - 12

oprawa / cover

1 4 - RE-COVER, 2 6 - SAVANA, 3 5 - CANVAS

znakowanie / marking method

1 - szycie kreatywne / creative stitching, 2 3 - tłoczenie / debossing,

dodatek / add-on

1 4 - druk UV / UV print, 5 6 - tłoczenie, szycie kreatywne / debossing, creative stitching

łączenie opraw / cover combinations*

N1, 3 - patka autorska / customised leather tab

4 - 19

* wybór dostępnych łączeń opraw na stronie 94. / selection of available templates for cover combinations on page 94.



COMPANY
OF THE FUTURE





PAPIER Z NASIONAMI ZAWIERA MIX KWIATÓW POLNYCH: MAK POLNY, STOKROTKA, NIEZAPOMINAJKA I FIRLETKA / paper with seeds contains mix of field flowers: field poppy, daisy, forget-me-not and catchfly



WKLEJKA / insert page

kształty / shapes

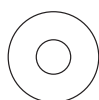

1 - Ø 90 mm



3 - 95 × 80 mm



5 - 68 × 90 mm



7 - 95 × 80 mm



2 - 80 × 90 mm



4 - 95 × 60 mm



6 - 90 × 90 mm



8 - 90 × 90 mm

PAPIER Z NASIONAMI

paper with seeds



Posadź,
Podlewaj!
sow & flow!

Zobacz
co wyrośnie!
witness the blossom

SITŁA UKRYTA W NASIONACH

the power dormant in seeds

METODY ZNAKOWANIA / marking methods



TŁOCZENIE / debossing



TŁOCZENIE FOLIA / foil debossing



DRUK SUBLIMACYJNY / sublimation print

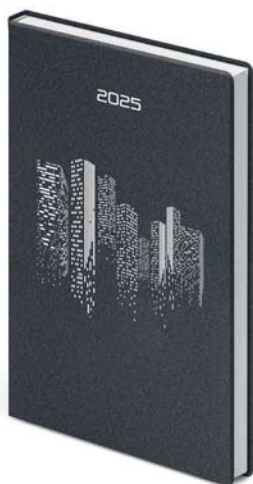

DRUK MONOCHROMATYCZNY BIAŁY /
white monochrome printing



DRUK KOLOROWY UV / UV colour printing

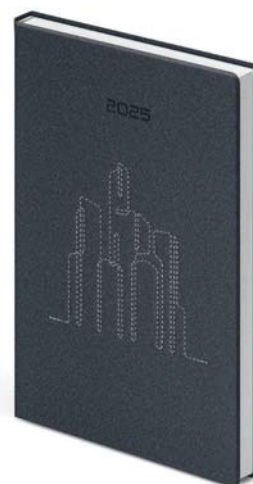

SZYCIE KREATYWNE / creative stitching

inspiracja / inspiration

rok / year design

znakowanie / marking method*

2B

różne metody znakowania / various marking methods

* dedykowane znakowanie opraw zamieszczone na stronie 11. / dedicated marking methods of covers available on page 11.

ZNAKOWANIE OPRAW / cover marking methods

OPRAWA cover	TŁOCZENIE debossing	TŁOCZENIE FOLIĄ foil debossing	GRAWER engraving	SZYCIE creative stitching	DRUK print
LINO					✓
SENSO	✓	✓	✓	✓	✓
LAVA	✓		✓	✓	✓
COLORI					✓
rPET					✓ sublimacja / sublimation
QUERK					✓
RE-COVER				✓	✓
SAVANA	✓		✓	✓	✓
NATURA	✓	✓	✓	✓	✓
GAMBO	✓		✓	✓	✓
CROSS	✓		✓	✓	✓
CANVAS	✓		✓	✓	✓
IDEO	✓	✓	✓	✓	✓
PIKO	✓		✓	✓	✓
GUMA	✓	✓	✓	✓	✓
IMAGE	✓	✓	✓	✓	✓
CARBON	✓		✓	✓	✓
COLORADO	✓	✓	✓	✓	✓
KRAFT	✓	✓	✓	✓	✓
FLESZ	✓	✓	✓	✓	✓
VIVELA	✓	✓	✓	✓	✓
ITALIANO	✓	✓	✓		✓



inspiracja / inspiration

rok / year design

oprawa / cover

znakowanie / marking method

dodatek / add-on

12

LAVA

łtoczenie wielkoformatowe / large format debossing

M20B



inspiracja / inspiration

oprawa / cover

znakowanie / marking method

dodatek / add-on

SENSO

szycie kreatywne / creative stitching

M16, finochrom autorski / customised finochrome



SENSO

rok / year design

31

kolor / colour

zielony / green
granatowy / dark blue
grafitowy / graphite
czarny / black



F1 ^{NEW}
FORNIR / veneer

dedykowane znakowanie opraw zamieszczone na stronie 11., układy kalendarzy i notesów zamieszczone od strony 104. / dedicated cover marking methods available on page 11., calendar and notebook layouts available on page 104.



inspiracja / inspiration

rok / year design	12
oprawa / cover	SENSO
znakowanie / marking method	tłoczenie / debossing
dodatek / add-on*	F1 ^{NEW}
łączenie opraw / cover combinations**	31

* F1 tylko w łączeniu 31 na stronie 94. / F1 add-on only available in cover combination no. 31, details on page 94.
** wybór dostępnych łączeń opraw na stronie 94. / selection of available templates for cover combinations on page 94.

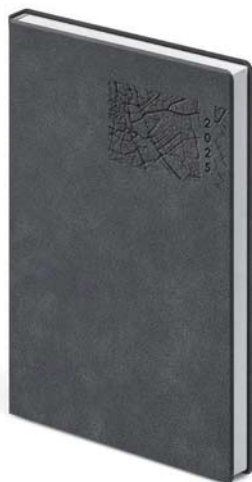
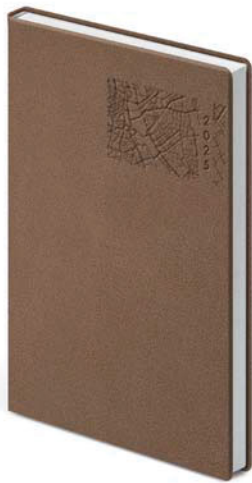

LAVA

rok / year design

29

kolor / colour

brązowy / brown
granatowy / dark blue
grafitowy / graphite
czarny / black



dedykowane znakowanie opraw zamieszczone na stronie 11., układy kalendarzy i notesów zamieszczone od strony 104. / dedicated cover marking methods available on page 11., calendar and notebook layouts available on page 104.



inspiracja / inspiration

rok / year design

28

oprawa / cover

LAVA

znakowanie / marking method

tłoczenie, szycie kreatywne / debossing, creative stitching



NATURALNY LEN

n a t u r a l l i n e n

LINO

rok / year design

drukowany / printed

kolor / colour

beżowy / beige



WORKI BAWĘLNIANE / cotton bags ^{NEW}

wymiar / size

materiał / material

znakowanie / marking method

pod każdy format z wykluczeniem kalendarza 504T i notesu A6 /
for any format except 504T calendar and A6 notebook

bawełna / cotton

termotransfer / thermal transfer

inspiracja / inspiration

rok / year design

oprawa / cover

znakowanie / marking method

opakowanie / packaging

drukowany / printed

LINO

druk / print

worek bawełniany / cotton bag

dedykowane znakowanie opraw zamieszczone na stronie 11., układy kalendarzy i notesów zamieszczone od strony 104. / dedicated cover marking methods available on page 11., calendar and notebook layouts available on page 104.



inspiracja / inspiration

rok / year design

oprawa / cover

znakowanie / marking method

dodatek / add-on

drukowany / printed

LINO

druk / print

gumka pionowa płaska 10 mm / 10 mm vertical elastic band



SUBLIMACJA NIE TYLKO KALENDARZE...

sublimation
not only calendars...

sub[®]
LINE
PRINT





rPET

rok / year design

drukowany / printed

kolor / colour

biały / white

MOŻLIWOŚĆ PERSONALIZACJI W DOWOLNYM KOLORZE

possibility of personalisation
in any color

rPET jest materiałem recyklingowym pozyskiwanym w 100% z odpadów pokonsumpcyjnych, najczęściej z butelek typu PET. Na 1 m² wykorzystuje się 12 butelek 1,5 litrowych. Materiał recyklingowy przeznaczony do druku sublimacyjnego – wg CMYK.

rPET is a recyclable material obtained in 100% from post-consumer waste, most often from PET bottles. 12 bottles of 1.5 liters are used per 1 m². The recycled material is intended for sublimation printing – according to CMYK.



dedykowane znakowanie opraw zamieszczone na stronie 11., układy kalendarzy i notesów zamieszczone od strony 104. / dedicated cover marking methods available on page 11., calendar and notebook layouts available on page 104.



inspiracja / inspiration

oprawa / cover

znakowanie / marking method

rPET

druk sublimacyjny / sublimation printing

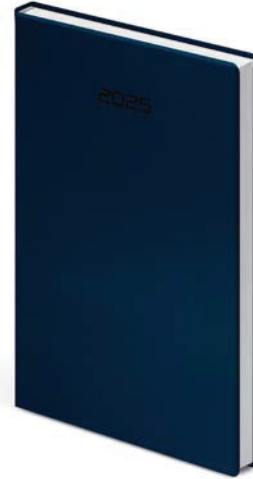

COLORI



rok / year design

drukowany / printed

oprawa / cover

papier / paper

kolor / colour

brzoskwiniowy / peach
czerwony / red
seledynowy / willow-green
zielony / green
niebieski / blue
granatowy / dark blue
szary / grey
czarny / black

dedykowane znakowanie opraw zamieszczone na stronie 11., układy kalendarzy i notesów zamieszczone od strony 104. / dedicated cover marking methods available on page 11., calendar and notebook layouts available on page 104.



inspiracja / inspiration

rok / year design

oprawa / cover

znakowanie / marking method

drukowany / printed

COLORI

lakier UV, druk CMYK / UV varnish, CMYK print



NAKLEJKA METALICZNA /
metallic sticker

NAKLEJKA METALICZNA
O DOWOLNYM KSZTAŁCIE,
BAZA SZCZOTKOWANA
LUB BŁYSZCZĄCA
(ZŁOTO, SREBRO, MIEDŹ)
Z NADRUKIEM UV CMYK /
metallic sticker – available in any shape,
brushed or shiny base (gold, silver, copper)
with UV CMYK print



NAKLEJKA METALICZNA 3D /
3D metallic sticker

NAKLEJKA METALICZNA 3D
O DOWOLNYM KSZTAŁCIE,
BAZA SZCZOTKOWANA
LUB BŁYSZCZĄCA
(ZŁOTO, SREBRO, MIEDŹ)
Z EFEKTEM WYPUKŁOŚCI
W KOLORZE CMYK /
3D metallic sticker – available in any
shape, brushed or shiny base (gold, silver,
copper) with bulge effect, CMYK print

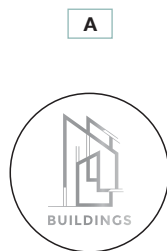

M22, M23, M24 – METALOWA
ZAWIESZKA NA GUMKĘ 1 cm
Z WYKOŃCZENIEM BŁYSZCZĄCYM
MOŻLIWOŚĆ UMIESZCZENIA
LOGOTYPÓW W PONIŻSZYCH
WARIANTACH: **A, B, C** /
metallic plate mounted on elastic band
1cm with shiny finish. Logo placements
available in undermentioned variants:
A, B, C



A variant / variant

NAKLEJKA EPOKSYDOWA
Z LOGO O PODŁOŻU CMYK
ZE SREBRNYM FINOCHROMEM /
CMYK based epoxy sticker with silver
finochrome



B variant / variant

NAKLEJKA METALICZNA /
metallic sticker

C variant / variant

NAKLEJKA METALICZNA 3D /
3D metallic sticker

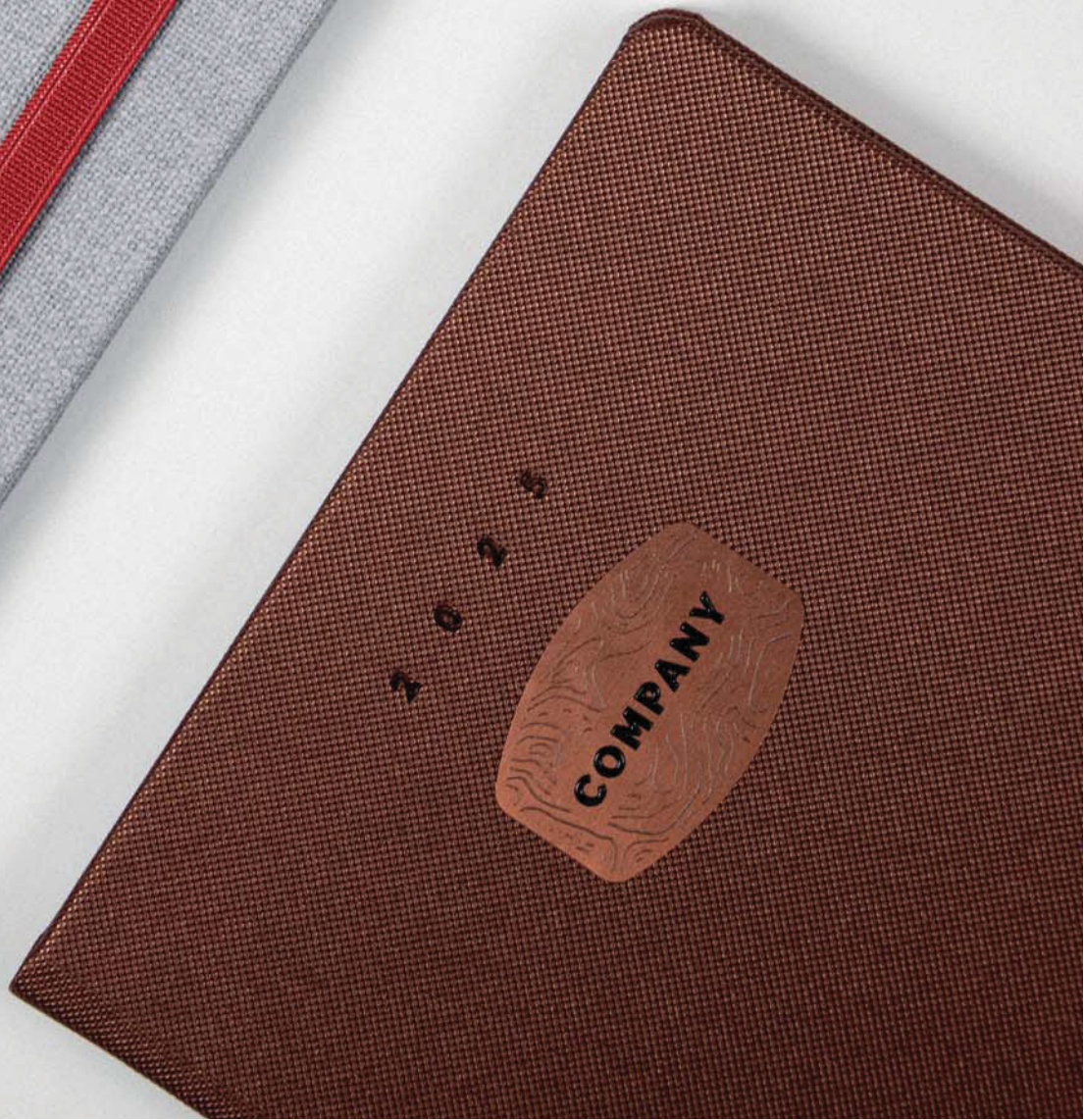

RE-COVER



RE-COVER



rok / year design

drukowany / printed

kolor / colour

beżowy / beige

grafitowy / graphite



Oprawa **RE-COVER** wykonana jest z surowca pozyskanego w procesie **recyklingu** skór naturalnych. Jest w pełni zgodna z rozporządzeniem REACH oraz konwencją waszyngtońską CITES. Parametry wytrzymałości są określone metodą EN ISO 3376:2011.

RE-COVER is made from material obtained through the **recycling** process of natural leathers. It is fully compliant with the REACH regulation and the Washington CITES Convention. The strength parameters are determined by the EN ISO 3376:2011 method.



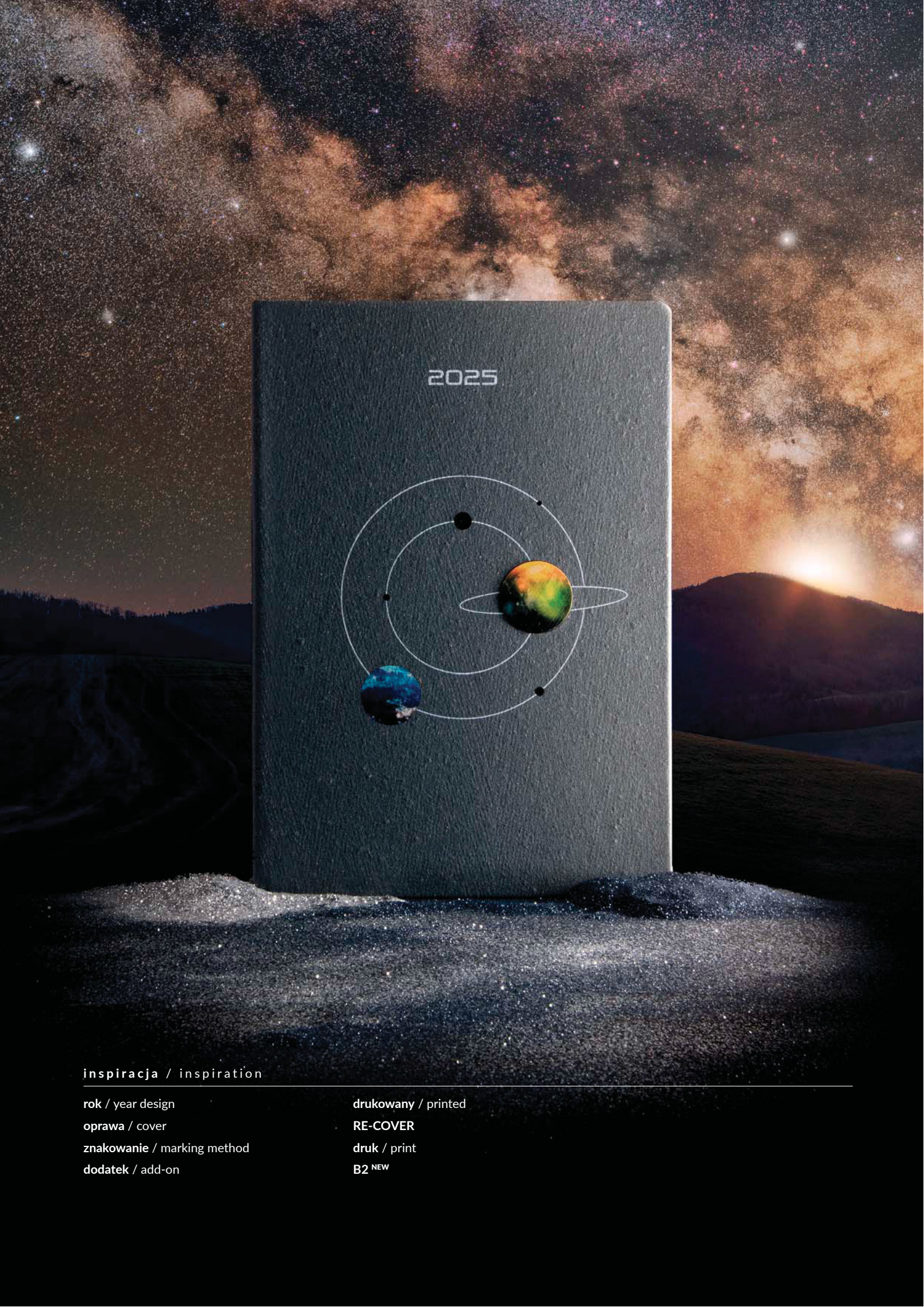

2025

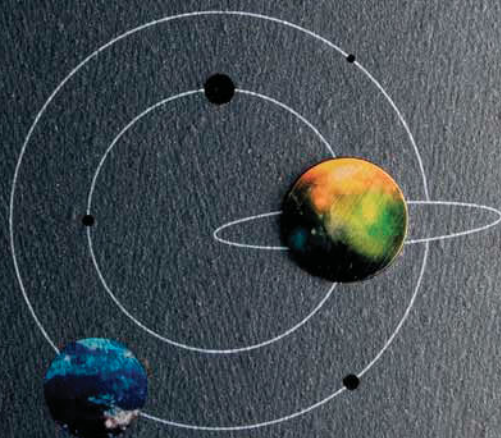

inspiracja / inspiration

rok / year design

oprawa / cover

znakowanie / marking method

dodatek / add-on

drukowany / printed

RE-COVER

druk / print

B2 NEW

QUERK



QUERK

rok / year design

drukowany / printed

kolor / colour

beżowy / beige

Korek to naturalny materiał pozyskiwany z kory dębu korkowego. Jest materiałem w pełni ekologicznym, a dodatkowo wegańskim. Nie ma dwóch takich samych fragmentów, co stanowi o wyjątkowości tego materiału.

Cork is a natural material obtained from the bark of the Quercus Suber. It is a fully ecological material and, on top of that, vegan. There are no two identical pieces, which makes this material unique.



dedykowane znakowanie opraw zamieszczone na stronie 11., układy kalendarzy i notesów zamieszczone od strony 104. / dedicated cover marking methods available on page 11., calendar and notebook layouts available on page 104.

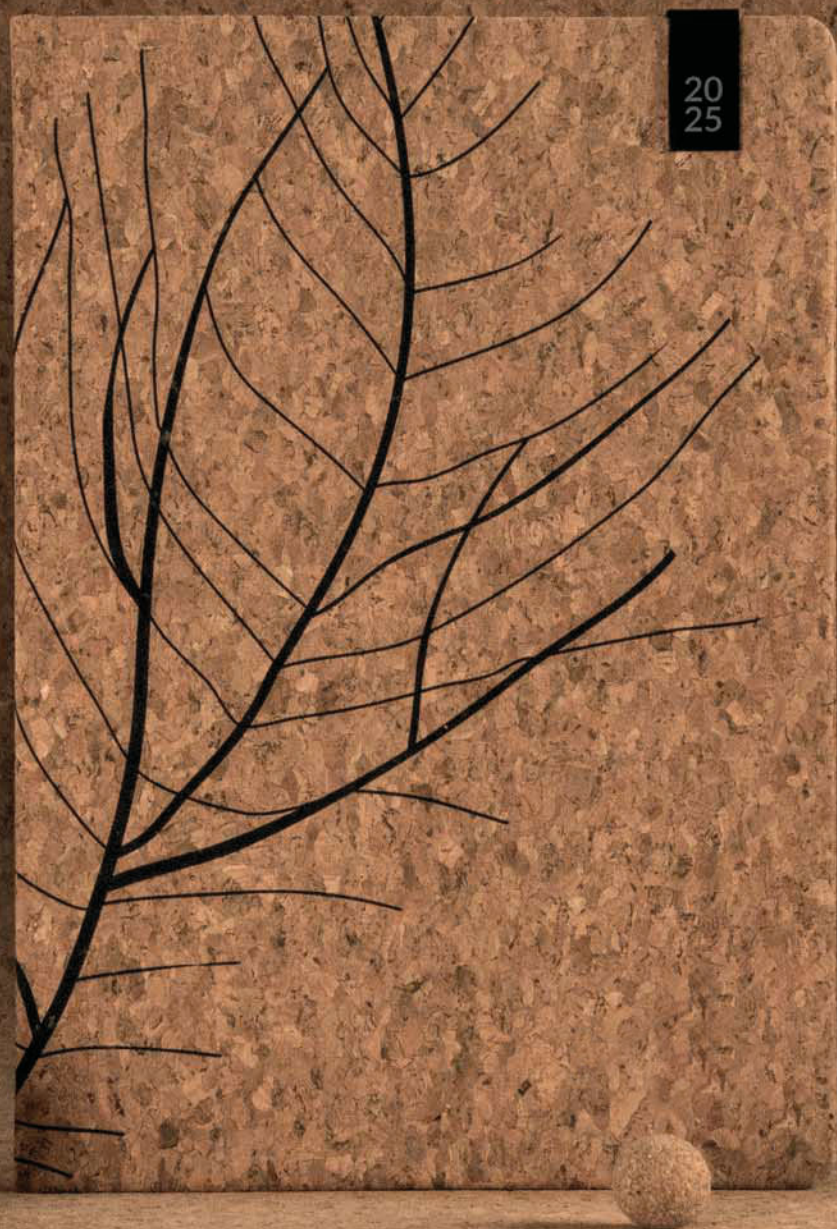

inspiracja / inspiration

rok / year design

oprawa / cover

znakowanie / marking method

dodatek / add-on

grawer / engraving

QUERK

druk / print

M16

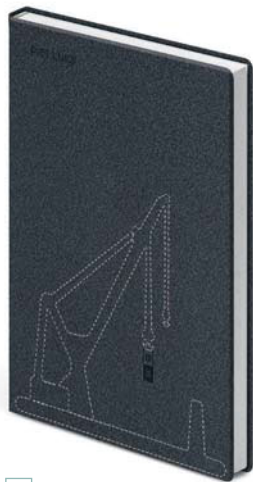

1



2



3



4



5

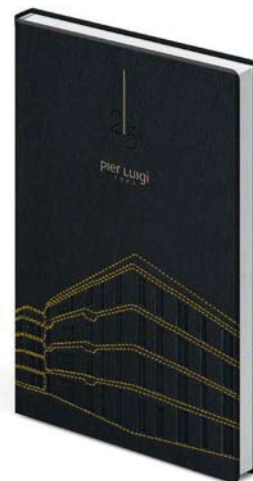

6

inspiracja / inspiration

rok / year design

oprawa / cover

znakowanie / marking method

dodatek / add-on

1 - 8, 3 - M4, 5 - 12, 6 - 20A

1 - KRAFT, 2, 4 - CANVAS, 3 - IDEO, 5 - SAVANA, 6 - GAMBO

szycie kreatywne / creative stitching, tłoczenie / debossing, 4 - druk UV / UV print

6 - finochrom autorski / customised finochrome



inspiracja / inspiration

rok / year design

oprawa / cover

znakowanie / marking method

dodatek / add-on

1C

CANVAS

szycie kreatywne / creative stitching

M17B

NATURA

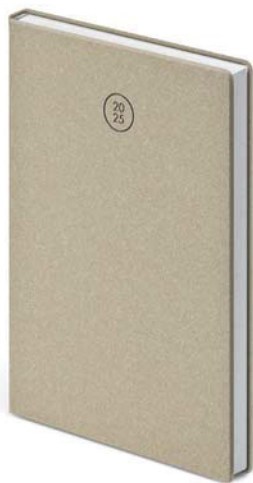

NATURA



rok / year design

4

oprawa / cover

papier / paper

kolor / colour

beżowy / beige

granatowy / dark blue

grafitowy / graphite

szary / grey



**100% EKOLOGICZNA
OPRAWA NATURA -
SUROWIEC POCHODZĄCY
Z LASÓW ZARZĄDZANYCH
ZGODNIE Z ZASADAMI
ZRÓWNOWAŻONEGO ROZWOJU.**

100% ecological **NATURA** cover – material originating from forests managed in accordance with the principles of sustainable development.



dedykowane znakowanie opraw zamieszczone na stronie 11., układy kalendarzy i notesów zamieszczone od strony 104. / dedicated cover marking methods available on page 11., calendar and notebook layouts available on page 104.



inspiracja / inspiration

rok / year design

oprawa / cover

znakowanie / marking method

dodatek / add-on

drukowany / printed

NATURA

druk w jednym kolorze / one colour printing

M20A

SAVANA

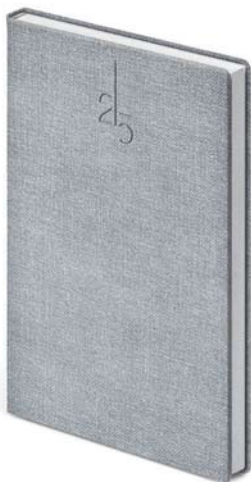
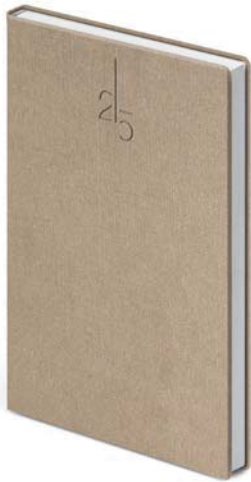

SAVANA



rok / year design

20

oprawa / cover

papier / paper

kolor / colour

beżowy / beige

grafitowy / graphite

szary / grey

granatowy / dark blue

**100% EKOLOGICZNA
OPRAWA SAVANA –
SUROWIEC POCHODZĄCY
Z LASÓW ZARZĄDZANYCH
ZGODNIE Z ZASADAMI
ZRÓWNOWAŻONEGO ROZWOJU.**

100% ecological **SAVANA** cover –
material originating from forests
managed in accordance with the
principles of sustainable development.

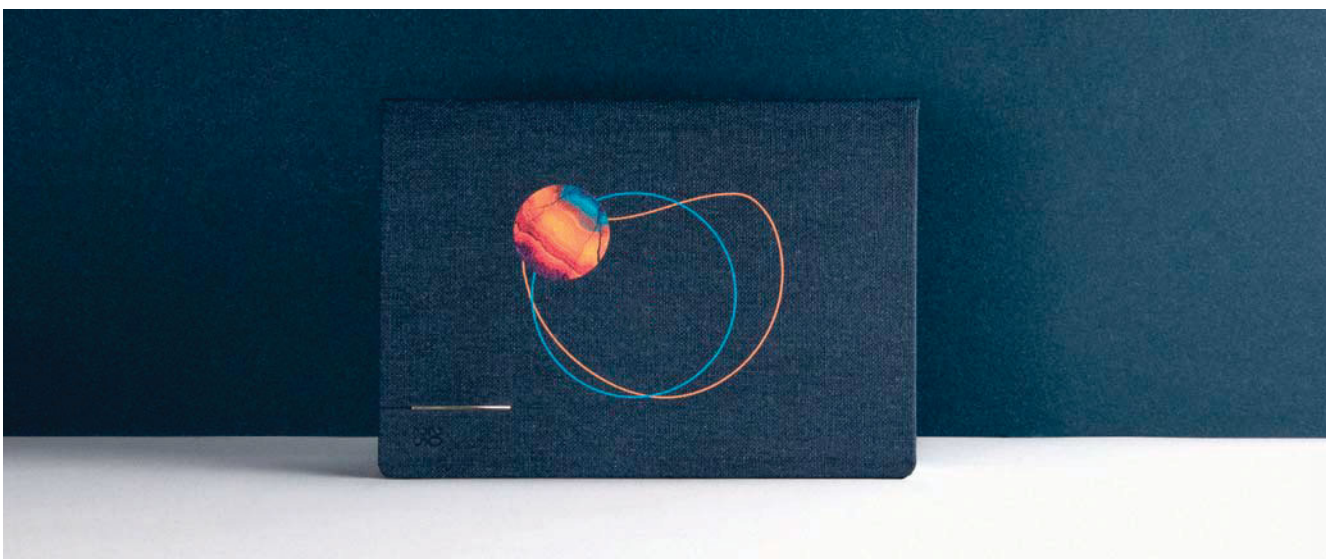

dedykowane znakowanie opraw zamieszczone na stronie 11., układy kalendarzy i notesów zamieszczone od strony 104. / dedicated cover marking methods available on page 11., calendar and notebook layouts available on page 104.

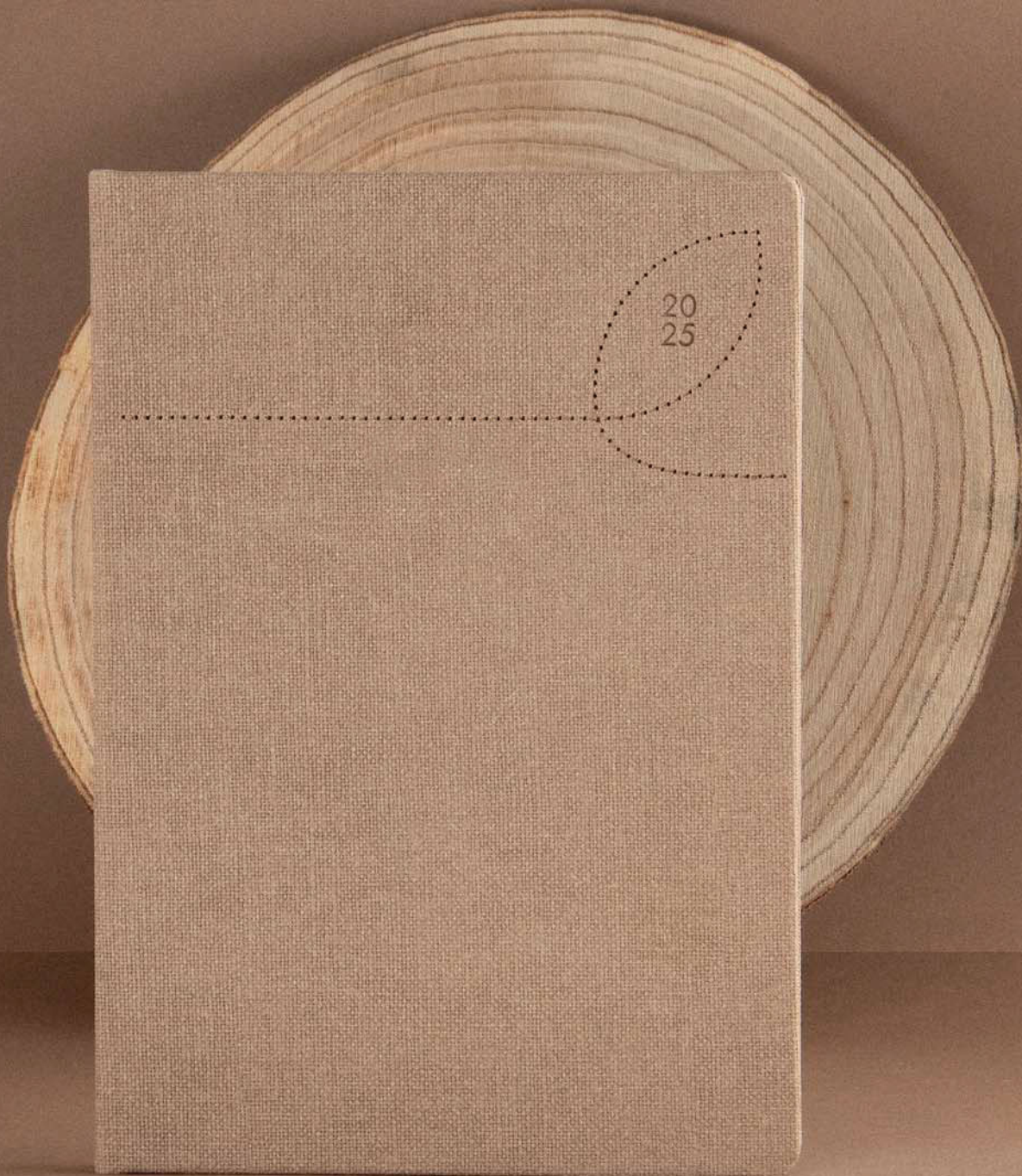

inspiracja / inspiration

rok / year design

oprawa / cover

znakowanie / marking method

7

SAVANA

tłoczenie, szycie kreatywne / debossing, creative stitching

GAMBO

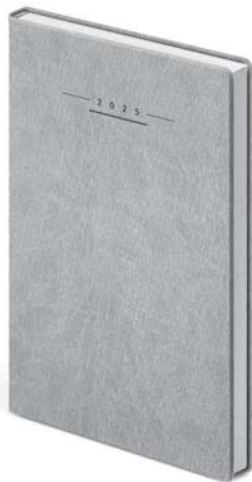

GAMBO

rok / year design

22

kolor / colour

zielony / green
brązowy / brown
szary / grey
czarny / black



dedykowane znakowanie opraw zamieszczone na stronie 11., układy kalendarzy i notesów zamieszczone od strony 104. / dedicated cover marking methods available on page 11., calendar and notebook layouts available on page 104.



inspiracja / inspiration

rok / year design

oprawa / cover

znakowanie / marking method

B3^{NEW}, B1

GAMBO

tłoczenie, szycie kreatywne / debossing, creative stitching

CROSS



dedykowane znakowanie opraw zamieszczone na stronie 11., układy kalendarzy i notesów zamieszczone od strony 104. / dedicated cover marking methods available on page 11., calendar and notebook layouts available on page 104.



inspiracja / inspiration

rok / year design

12

oprawa / cover

CROSS

znakowanie / marking method

łoczenie wielkoformatowe, szycie kreatywne / large format debossing, creative stitching

dodatek / add-on

M17B

COLORADO

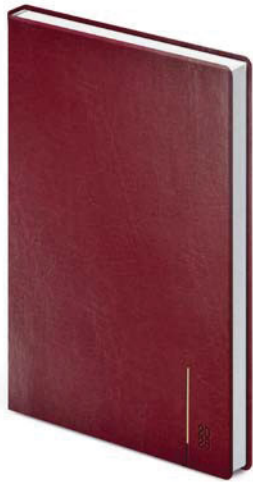

COLORADO

rok / year design

17A

kolor / colour

bordowy / maroon
czarny / black
granatowy / dark blue
czekoladowy / chocolate

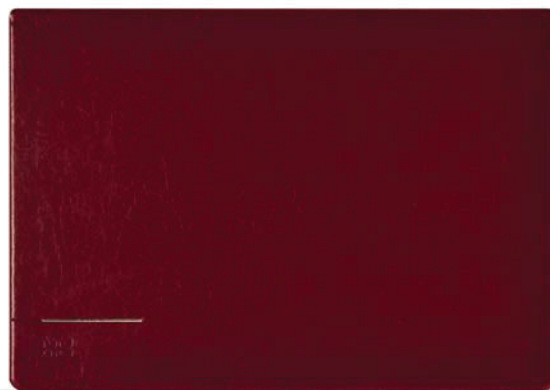



inspiracja / inspiration

rok / year design

oprawa / cover

znakowanie / marking method

25B, 24A

COLORADO

tłoczenie, obszycie / debossing, cover stitching

PIKO



PIKO

rok / year design

26

kolor / colour

szary / grey
czarny / black
granatowy błysk / dark blue shiny
brązowy / brown

FLESZ

FLESZ

rok / year design

1A

kolor / colour

srebrny / silver
złoty / gold

dedykowane znakowanie opraw zamieszczone na stronie 11., układy kalendarzy i notesów zamieszczone od strony 104. / dedicated cover marking methods available on page 11., calendar and notebook layouts available on page 104.



inspiracja / inspiration

rok / year design

20

oprawa / cover

PIKO, FLESZ

łączenie opraw / cover combinations

22

znakowanie / marking method

tłoczenie / debossing

GUMA

DRUK UV / UV print

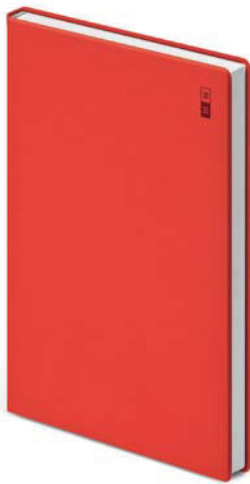

GUMA

rok / year design

8

kolor / colour

biały / white

szary / grey

granatowy / dark blue

czerwony / red

czarny / black



dedykowane znakowanie opraw zamieszczone na stronie 11., układy kalendarzy i notesów zamieszczone od strony 104. / dedicated cover marking methods available on page 11., calendar and notebook layouts available on page 104.



inspiracja / inspiration

rok / year design

oprawa / cover

znakowanie / marking method

dodatek / add-on

25B

GUMA

tłoczenie wielkoformatowe, szycie kreatywne / large format debossing, creative stitching

M16, finochrom autorski / customised finochrome



dedykowane znakowanie opraw zamieszczone na stronie 11., układy kalendarzy i notesów zamieszczone od strony 104. / dedicated cover marking methods available on page 11., calendar and notebook layouts available on page 104.

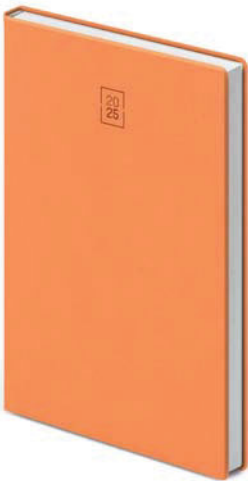
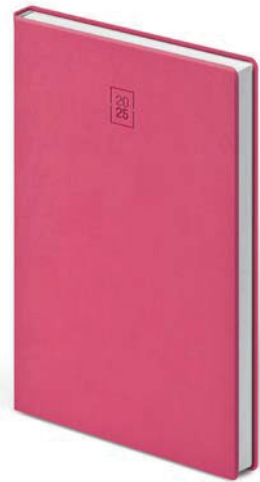
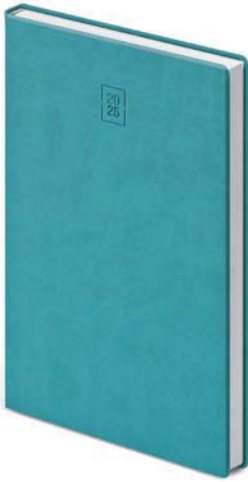

VIVELA

rok / year design

3

kolor / colour

czarny / black
szary / grey
niebieski / blue
granatowy / dark blue

zielony / green
seledynowy / willow-green NEW
turkusowy / turquoise
czerwony / red

magenta / magenta
pomarańczowy / orange
żółty / yellow
beżowy / beige



inspiracja / inspiration

rok / year design

oprawa / cover

znakowanie / marking method

dodatek / add-on

12

VIVELA

łtroczenie wielkoformatowe / large format debossing

M20A



inspiracja / inspiration

rok / year design

oprawa / cover

znakowanie / marking method

dodatek / add-on

12

VIVELA

grawer / engraving

gumka pionowa płaska 10 mm + M15, szlufka na długopis /
10 mm vertical elastic band + M15, elastic pen holder



1



2

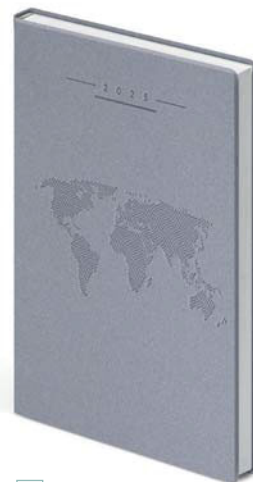

3

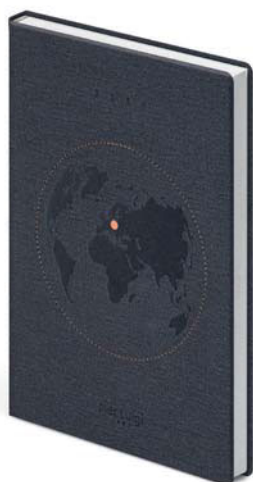

4

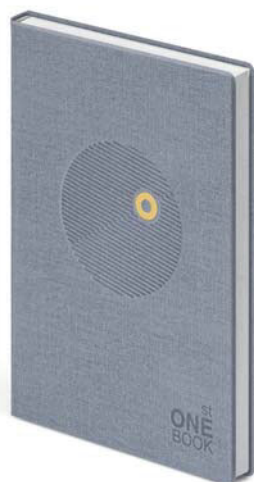

5



6

inspiracja / inspiration

rok / year design

1 2 4 - 12, 3 - 22, 6 - 7

oprawa / cover

1 - GUMA, 2 3 - NATURA, 4 - CANVAS, 5 - SAVANA, 6 - IDEO

znakowanie / marking method

tłoczenie wielkoformatowe / large format debossing, 4 - szycie kreatywne / creative stitching

dodatek / add-on

2 - M20A, 4 - M17C, 5 - M19

prezentowane matryce do tłoczeń wielkoformatowych na stronie 102-103 / presented stamps used for the large format debossings are on pages 102-103



inspiracja / inspiration

oprawa / cover

znakowanie / marking method

dodatek / add-on

IDEO

tłoczenie / debossing

M18A

CANVAS

Druk UV / UV print

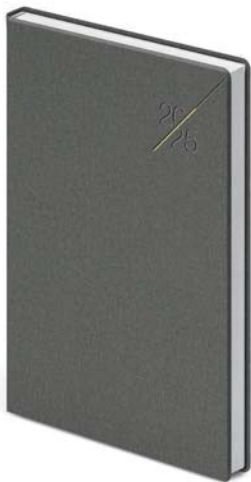
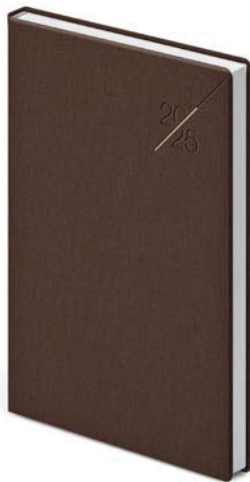
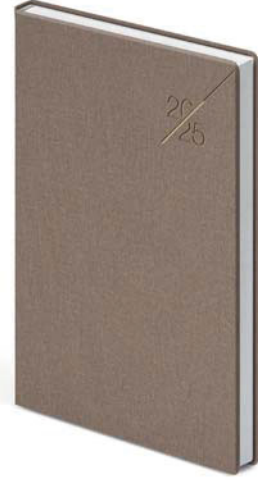

dedykowane znakowanie opraw zamieszczone na stronie 11., układy kalendarzy i notesów zamieszczone od strony 104. / dedicated cover marking methods available on page 11., calendar and notebook layouts available on page 104.

WYRAŻ SIEBIE W DRUKU

print your
personality



<< CANVAS

rok / year design

16A

kolor / colour

biały / white
czerwony / red
zielony / green
niebieski / blue
granatowy / dark blue
beżowy / beige
brązowy / brown
szary / grey
czarny / black

inspiracja / inspiration

oprawa / cover

znakowanie / marking method

CANVAS

druk UV / UV print

CANVAS LINE



LINE 1



LINE 4



LINE 5

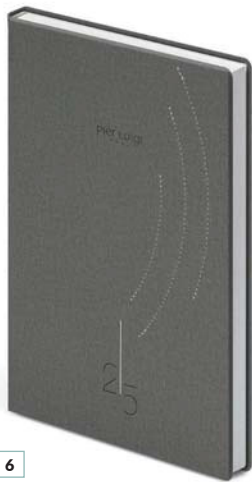

LINE 6



LINE 7 NEW



LINE 8 NEW

inspiracja / inspiration

rok / year design

oprawa / cover

znakowanie / marking method

projekt / design

dodatek / add-on

LINE 1 - 12, LINE 4 - 9, LINE 5 - 16A, LINE 6 - 20B, LINE 7 - 12, LINE 8 - 7

CANVAS

tłoczenie, szycie kreatywne / debossing, creative stitching

kolor oprawy i nici do wyboru / cover colours and sewing threads to choose

LINE 7 - M20A, LINE 8 - M17B

dedykowane znakowanie opraw zamieszczone na stronie 11., układy kalendarzy i notesów zamieszczone od strony 104. / dedicated cover marking methods available on page 11., calendar and notebook layouts available on page 104.

20
25

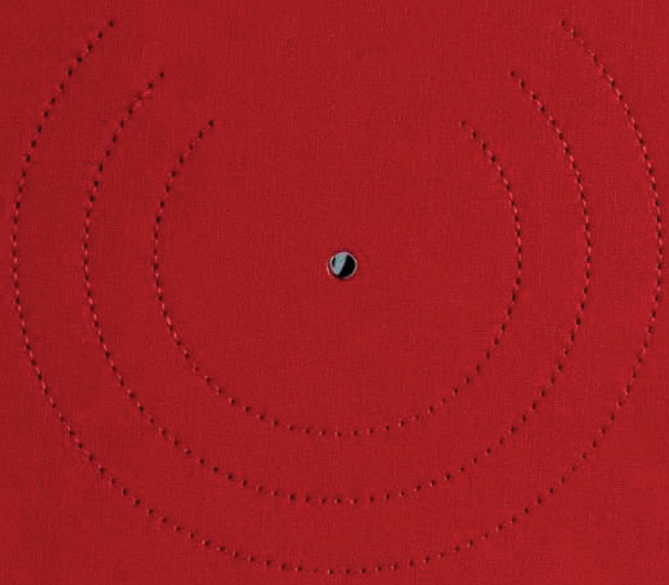

CANVAS - SPINE / HORIZONT



CANVAS - SPINE / HORIZONT

rok / year design

oprawa / cover

łączenie opraw / cover combinations*

znakowanie / marking method

projekt / design

1 - 27A, **2** - 26A

CANVAS + CANVAS

1 - 28 HORIZONT, **2** - 10 SPINE

druk UV, tłoczenie / UV print, debossing

kolor oprawy i nici do wyboru / cover colours and sewing threads to choose

* łączenie opraw canvas - spine / horizont tylko na tekturze twardej / connecting canvas cover material - spine / horizont only available on hardcovers

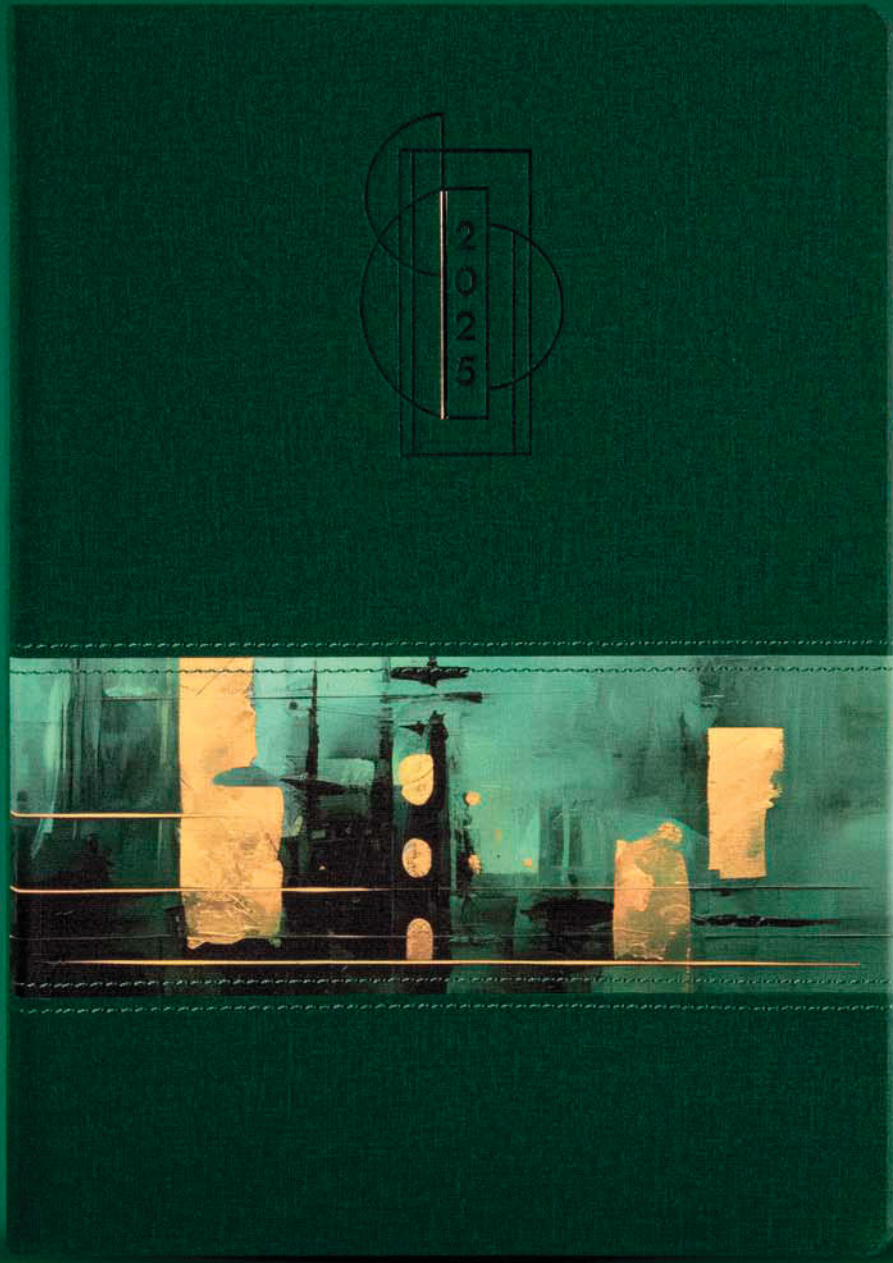



BANDEROLA STONEBOOK

stonebook banderole*

* do każdego zamówienia kalendarzy lub notesów z kamienia, banderola z informacją o papierze gratis (na życzenie klienta) / free banderole with information about the paper for each stone paper calendar or notebook order (at customer's request)

**EKOLOGICZNY
WODOODPORNY
WYTRZYMAŁY**

**ECOLOGICAL
WATER-RESISTANT
DURABLE**

**PAPIER
STWORZONY
Z KAMIENIA**

paper made out of stone

st[®]
**ONE
BOOK**

KRAFT



KRAFT

rok / year design

25C

kolor / colour

grafitowy / graphite



inspiracja / inspiration

rok / year design

oprawa / cover

znakowanie / marking method

dodatek / add-on

7, 25B

KRAFT

tłoczenie, szycie kreatywne / debossing, creative stitching

M17B, szlufka na długopis / pen holder

dedykowane znakowanie opraw zamieszczone na stronie 11., układy kalendarzy i notesów zamieszczone od strony 104. / dedicated cover marking methods available on page 11., calendar and notebook layouts available on page 104.

IMAGE



IMAGE

rok / year design

4A

kolor / colour

czarny / black



inspiracja / inspiration

rok / year design

oprawa / cover

znakowanie / marking method

dodatek / add-on*

9

IMAGE

grawer / engraving

M8 - 32 GB

* z wyłączeniem formatu kalendarza 504T, oprawy rPET i opraw typu flexi / does not apply to calendar 504T, rPET cover and flexi cover

METALLIC PRINT



inspiracja / inspiration

wymiar / size

oprawa / cover*

uszlachetnienie oprawy / cover refinement

wykończenie / finishing

nakład / print run

pod każdy format / for any format

papier / paper

folia soft touch / soft touch foil

METALLIC PRINT – złoty, srebrny, hologramowy / gold, silver, hologram

min. 200 szt. / MOQ 200 pcs.



* narożniki okładki papierowej z METALLIC PRINT, tylko proste rogi na tekturze twardej / hardcover and straight corners are mandatory for METALLIC PRINT



Druk UV / UV print



IDEO

rok / year design

24B

kolor / colour

biały / white
seledynowy / willow-green
czerwony / red
granatowy / dark blue
czarny / black
szary / grey
jasny brąz / light brown
bordowy / maroon

dedykowane znakowanie opraw zamieszczone na stronie 11., układy kalendarzy i notesów zamieszczone od strony 104. / dedicated cover marking methods available on page 11., calendar and notebook layouts available on page 104.



inspiracja / inspiration

rok / year design

oprawa / cover

znakowanie / marking method

dodatek / add-on

7

IDEO

tłoczenie, szycie kreatywne / debossing, creative stitching

M17B



CHEVRON



DUNES



CARO



VENUS



SQUARES



OVAL



DROP NEW



VICTORY



HILLS

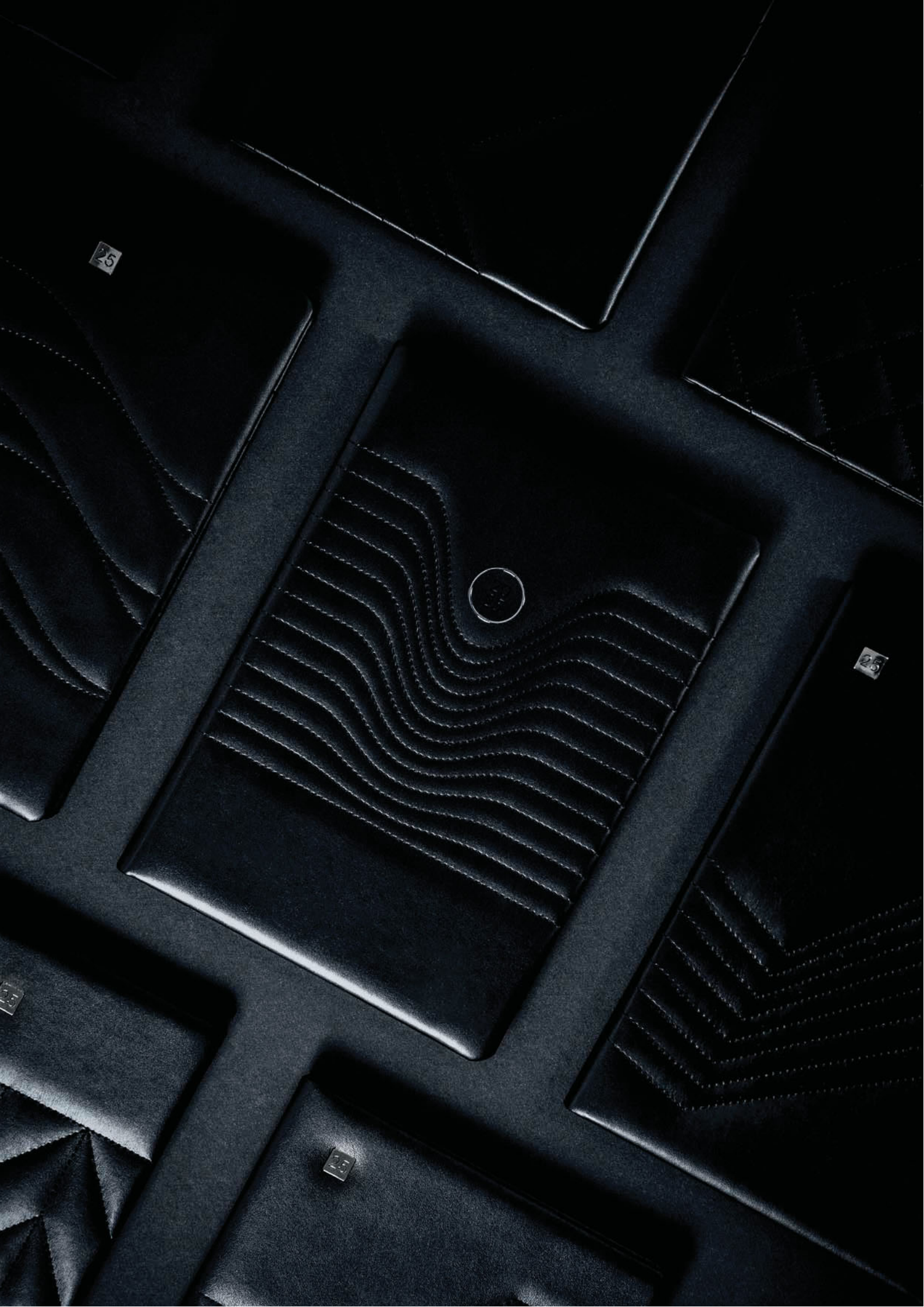

25



25

25

25

CARBON



CARBON

rok / year design

M3

kolor / colour

granatowy / dark blue

czarny / black

szary / grey



LUNGO NEW

rok / year design

oprawa / cover

łączenie opraw / cover combinations*

M4

CARBON + VIVELA

30 NEW

* wybór dostępnych łączeń opraw na stronie 94. / selection of available templates for cover combinations on page 94.
dedykowane znakowanie opraw zamieszczone na stronie 11., układy kalendarzy i notesów zamieszczone od strony 104. / dedicated cover marking methods available on page 11.,
calendar and notebook layouts available on page 104.



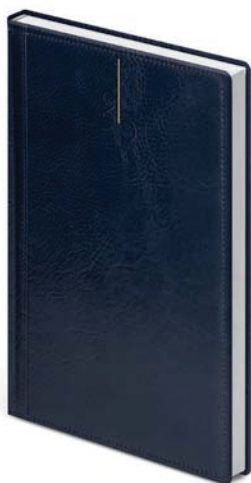

SKÓRA NATURALNA

garbowana roślinnie

natural vegetable
tanned leather



ITALIANO

rok / year design

20A

kolor / colour*

granatowy / dark blue

brązowy / brown

czarny / black

* zróżnicowany kolor skóry i występujące na niej zagięcia są jej naturalnymi elementami i stanowią o jej wyjątkowym wyglądzie - te elementy nie podlegają reklamacji / the varied colour of the leather and the folds on it are its natural elements and determine its unique appearance - these elements are not subject to complaint



inspiracja / inspiration

rok / year design

oprawa / cover

znakowanie / marking method

dodatek / add-on

30

ITALIANO

tłoczenie / debossing

M20B



TA SAMA OPRAWA, RÓŻNE WNĘTRZA

the same COVER, different interiors

KALENDARZE / NOTESY

calendars / notebooks



KALENDARZE BIURKOWE / desk calendars



KALENDARZ BIURKOWY TYGODNIOWY – LEŻĄCY Z KALENDARIUM 505T / 505T weekly desk lying calendar

kalendarz / calendar

leżący / lying

oprawa / cover*

wg wzornika opraw / according to cover set

* rodzaj i kolor oprawy do wyboru z wykluczeniem rPET i RE-COVER / type and colour of the cover material according to your choice, excluding rPET and RE-COVER covers

dedykowane znakowanie opraw zamieszczone na stronie 11., układy kalendarzy i notesów zamieszczone od strony 104. / dedicated cover marking methods available on page 11., calendar and notebook layouts available on page 104.

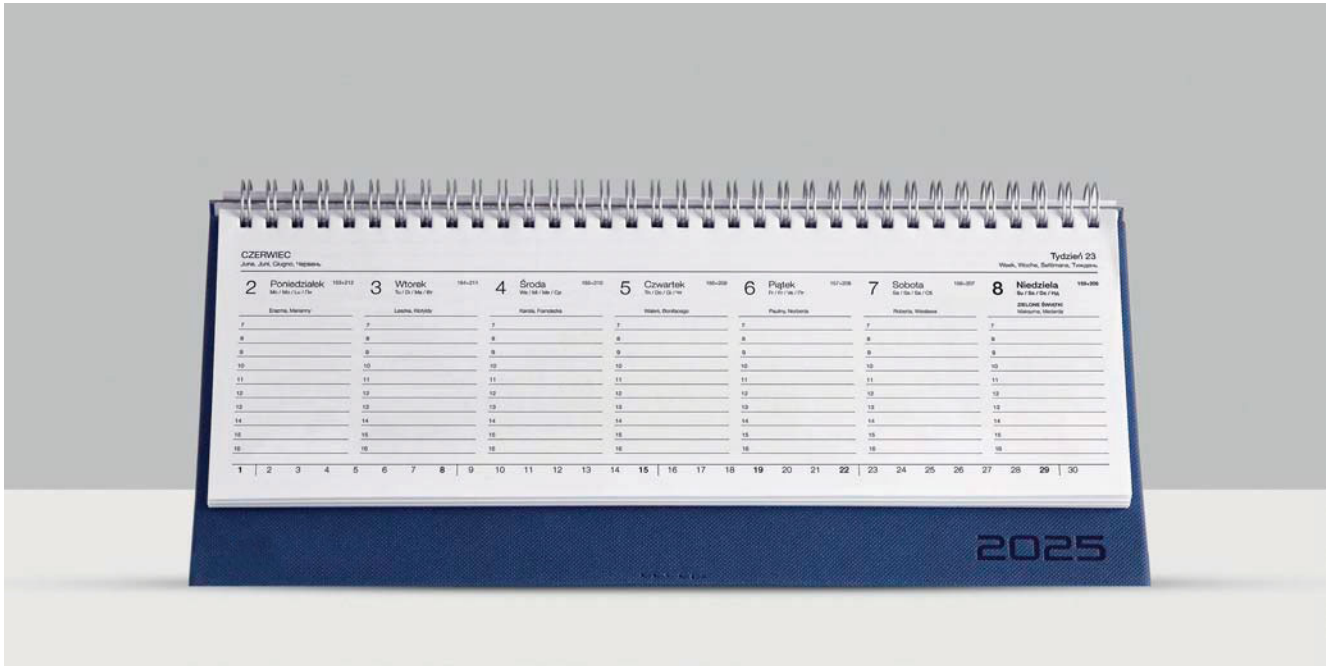

KALENDARZ BIURKOWY TYGODNIOWY – STOJĄCY Z KALENDARIUM 505T / 505T weekly desk standing calendar

kalendarz / calendar

stojący / standing

oprawa / cover*

wg wzornika opraw / according to cover set

* rodzaj i kolor oprawy do wyboru z wykluczeniem rPET i RE-COVER, pasek mocujący możliwy do wykonania jedynie z ekoskóry / type and colour of the cover material according to your choice, excluding rPET and RE-COVER covers, the fastening strap can only be made of eco-leather

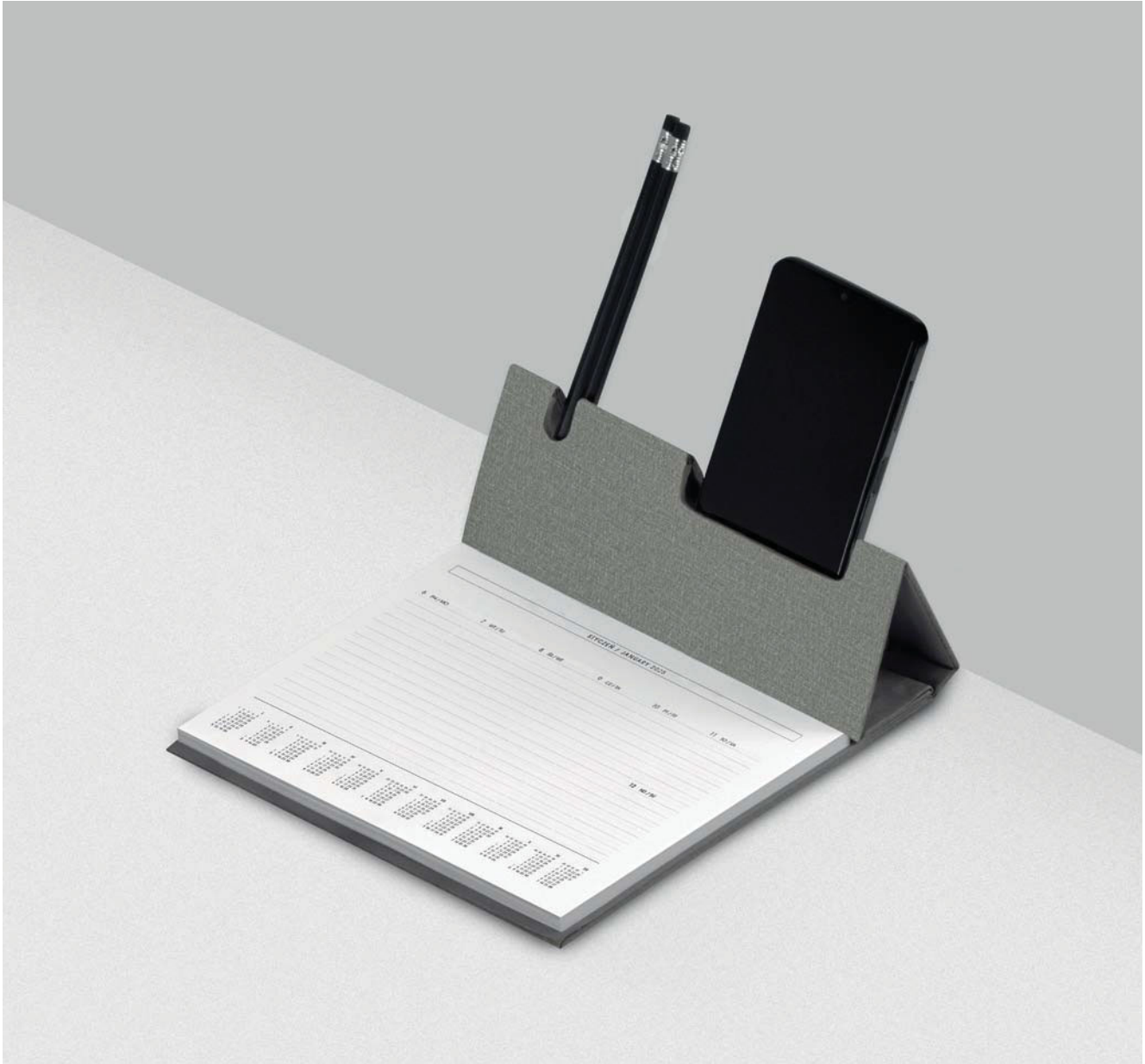

KALENDARZ BIURKOWY TYGODNIOWY 518T Z ORGANIZEREM / 518T weekly desk calendar with organiser **NEW**

kalendarz / calendar

wymiar / size

oprawa / cover*

znakowanie / marking method

wyklejka / endpaper

inne / other

leżący / lying

205 × 210 mm

CANVAS – szary, granatowy lub czarny / grey, dark blue or black

tłoczenie, grawer, druk UV / debossing, engraving, UV print

papier barwiony w masie pod kolor okleiny / mass dyed paper matching the cover colour

wycięcie pod długopis i telefon / cut-out for pen and mobile phone

* wybór innej okleiny możliwy od 500 sztuk / choice of other cover possible from 500 pcs



KALENDARZ BIURKOWY MIESIĘCZNY Z ŁADOWARKĄ INDUKCYJNĄ / monthly desk calendar with wireless charger ^{NEW}

numer katalogowy / catalogue number

G0085

kalendarz / calendar

stojący / standing

wymiar / size

180 × 135 × 14 mm

materiał / material

bambus + rPET / bamboo + rPET

znakowanie / marking method

druk UV / UV print

ładowarka indukcyjna / wireless charger

wejście / input: DC9V-2.0A / 12V-1.5A / 5V-2.0A

wyjście / output: 15 W

layout – szczegóły strona 123. / specification on page 123.

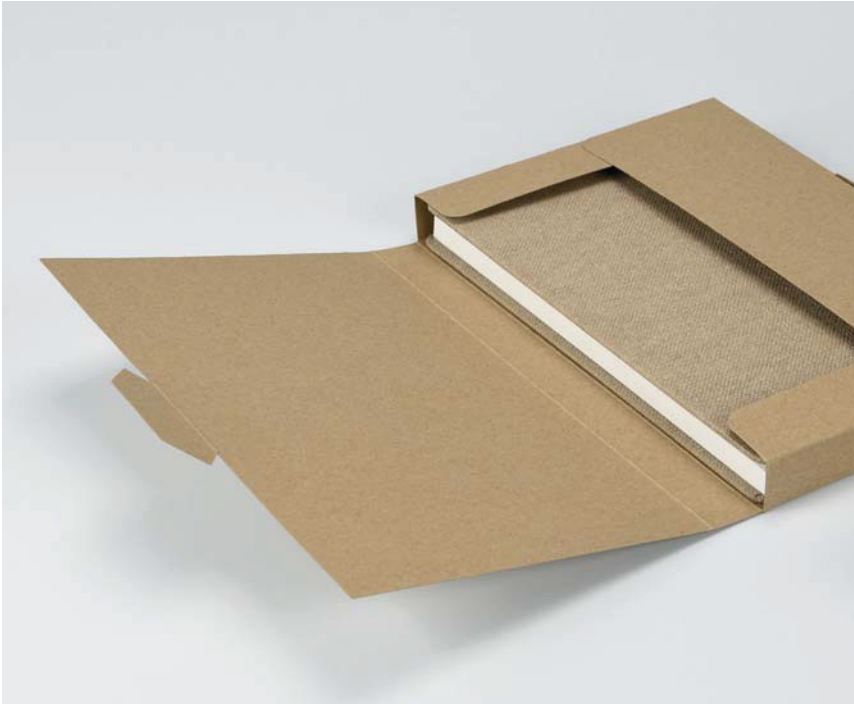

PUDEŁKO KOPERTOWE / envelope box • **PUDEŁKO WIECZKOWE** / box with a lid

wymiar / size

materiał / material*

znakowanie / marking method

pod każdy format z wykluczeniem kalendarza 504T i notes A6 /
for any format except 504T calendar and A6 notebook

papier barwiony w masie lub papier kraftowy / mass dyed paper or kraft paper

tłoczenie folią, sitodruk / foil debossing, silk-screen

* dostępne kolory na str 92. / available colours on page 92.





PUDEŁKO ZASUWANE / sliding box

wymiar / size

materiał / material*

znakowanie / marking method

pod każdy format z wykluczeniem kalendarza 504T i notes A6 /
for any format except 504T calendar and A6 notebook

papier barwiony w masie lub papier kraftowy / mass dyed paper or kraft paper

łoczenie folią, sitodruk / foil debossing, silk-screen

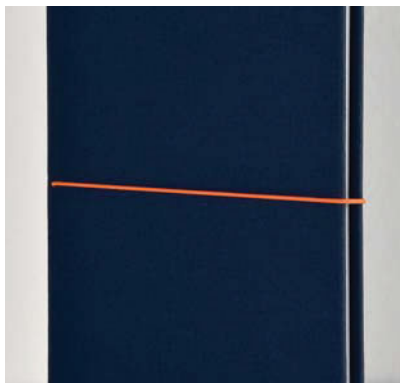

GUMKA POZIOMA OKRĄGŁA /
round horizontal elastic band*

szerokość / width

1,7 mm



**GUMKA GRZBIETOWA Z MIEJSCEM
NA DŁUGOPIS** / spine elastic band with
a pen holder

szerokość / width

10 mm



GUMKA PIONOWA PŁASKA /
flat vertical elastic band

szerokość / width

10 mm



SPOSÓB MONTOWANIA GUMKI NA TYLE OKŁADKI /
technique of assembling the elastic band on the back cover



GUMKA PIONOWA PŁASKA /
flat vertical elastic band

szerokość / width

10 mm

dodatek / add-on

M15

* montaż gumki okrągłej na grzbiecie tylko na twardej oprawie z wyłączeniem opraw papierowych, rPET, QUERK i formatu kalendarza 504T / assembly of the round elastic band only available on a hardcover excluding paper covers, rPET, QUERK and 504T calendar format



SZLUFKA NA DŁUGOPIS / pen holder

szerokość / width

10 mm

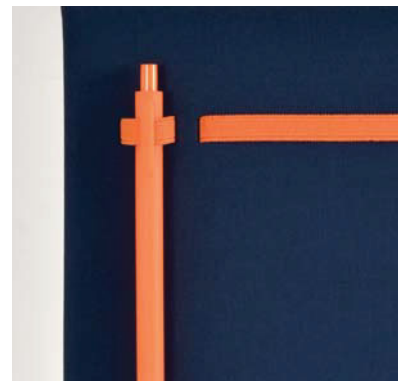

GUMKA POZIOMA PŁASKA
Z MIEJSCEM NA DŁUGOPIS /
flat horizontal elastic band with
a pen holder











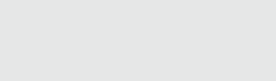













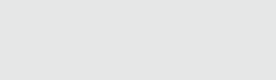













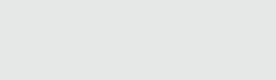

szerokość / width

10 mm

WZÓR UŻYTKOWY - URZĄD PATENTOWY RP /
utility model - patent office of the Republic of Poland

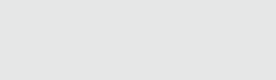

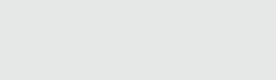
DODATKI / add-ons

GUMKA PŁASKA flat elastic band 10 mm	GUMKA OKRĄGŁA round elastic band 1,7 mm	TASIEMKA ribbon 6 mm	KOLOR colour
			biały / white
			czarny / black
			szary / grey
			brązowy / brown
			granatowy ciemny / navy blue
			granatowy jasny / light navy blue
			niebieski / blue
			żółty / yellow
			zielony / green
			seledynowy / willow-green
			bordowy / maroon
			czerwony / red
			pomarańczowy / orange
			magenta / magenta
			beżowy / beige





M1*

BLASZKA ALUMINIOWA /
aluminium plate

wymiar / size

40 × 14 mm

pole graweru / engraving area

38 × 12 mm



M3*

ROK FINOCHROMOWY
PRZYKLEJANY DO OPRAWY /
finochrome year stuck to cover

wymiar / size

41 × 8,5 mm



M4*

ROK FINOCHROMOWY
PRZYKLEJANY DO OPRAWY /
finochrome year stuck to cover

wymiar / size

10 × 10 mm



M8

PENDRIVE 32 GB MOCOWANY
W OPRAWIE / 32 GB flash drive holder
in the cover

wymiar / size

34 × 11 mm

pole graweru / engraving area

28 × 8 mm



M15

BLASZKA METALOWA (SREBRNA
MATOWA) MOCOWANA NA GUMCE
10 mm / rectangular (silver matt) metal
plate mounted on 10 mm elastic band

wymiar / size

45 × 14 mm

pole graweru / engraving area

34 × 12 mm



M16**

ZASUWKA METALOWA
(CZARNA MATOWA) MOCOWANA
NA TYLNEJ OPRAWIE Z KOPERTĄ /
metal hasp (black matt) mounted on
the back cover with envelope

wymiar / size

30 × 15 mm

pole graweru / engraving area

27 × 12 mm

* montaż 10 mm od brzegu oprawy / mounting 10 mm from the edge of cover

** dostępne w układzie dziennym i tygodniowym w kalendarzach i notesach / available for daily calendars, weekly calendars and notebooks



M17C*

KÓŁKO FINOCHROMOWE
MIEDZIANE, PRZYKLEJANE
DO OPRAWY / copper finochrome
dot stucked to cover

wymiar / size

5 × 5 mm



M17B*

KÓŁKO FINOCHROMOWE SREBRNE,
PRZYKLEJANE DO OPRAWY /
silver finochrome dot stucked to cover

wymiar / size

5 × 5 mm



N1*

NASIONA SOSNY / pine seeds

wymiar / size

12 × 12 mm

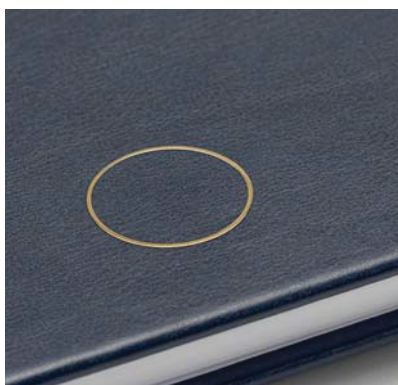

M18A*

OKRĄG FINOCHROMOWY ŻŁOTY,
PRZYKLEJANY DO OPRAWY / golden
finochrome circle stucked to cover

wymiar / size

23 × 23 mm



M18B*

OKRĄG FINOCHROMOWY SREBRNY,
PRZYKLEJANY DO OPRAWY / silver
finochrome circle stucked to cover

wymiar / size

23 × 23 mm



M19*

OKRĄG FINOCHROMOWY ŻŁOTY,
PRZYKLEJANY DO OPRAWY / golden
finochrome circle stucked to cover

wymiar / size

16 × 16 mm



M20A*

LINIA FINOCHROMOWA ŻŁOTA
PRZYKLEJANA DO OPRAWY /
golden finochrome line stuck to cover

wymiar / size

0,9 × 45 mm



M20B*

LINIA FINOCHROMOWA SREBRNA
PRZYKLEJANA DO OPRAWY /
silver finochrome line stuck to cover

wymiar / size

0,9 × 45 mm



M21*

BLASZKA ALUMINIOWA
POD PERSONALIZACJĘ /
aluminium plate for personalisation

wymiar / size

8 × 70 mm



F1*

FORNIR / veneer

wymiar / size

9,5 × 86 mm



PATKA MINI /**

mini leather tab

ZAMYKANA NA MAGNES,
MAGNES UKRYTY W OPRAWIE /
with magnetic closure, magnet hidden
in cover



PATKA MAXI /**

maxi leather tab

ZAMYKANA NA MAGNES
Z MIEJSCEM NA DŁUGOPIS,
MAGNES UKRYTY W OPRAWIE /
with magnetic closure and pen holder,
magnet hidden in cover

* montaż 10 mm od brzegu oprawy / assembly 10 mm from the edge of the cover

** z wyłączeniem opraw papierowych, rPET i RE-COVER / excluding paper, rPET, and RE-COVER covers



B1*
OKRĄG BAMBUSOWY Z ROKIEM 3D /
bamboo circle with 3D year

wymiar / size

30 × 30 mm



B2* NEW
OKRĄG BAMBUSOWY POD DRUK /
bamboo circle with print

wymiar / size

30 × 30 mm



B3* NEW
OWAL BAMBUSOWY Z ROKIEM 3D /
bamboo oval with 3D year

wymiar / size

14 × 40 mm



B4* NEW
OWAL BAMBUSOWY POD DRUK /
bamboo oval with print

wymiar / size

14 × 40 mm

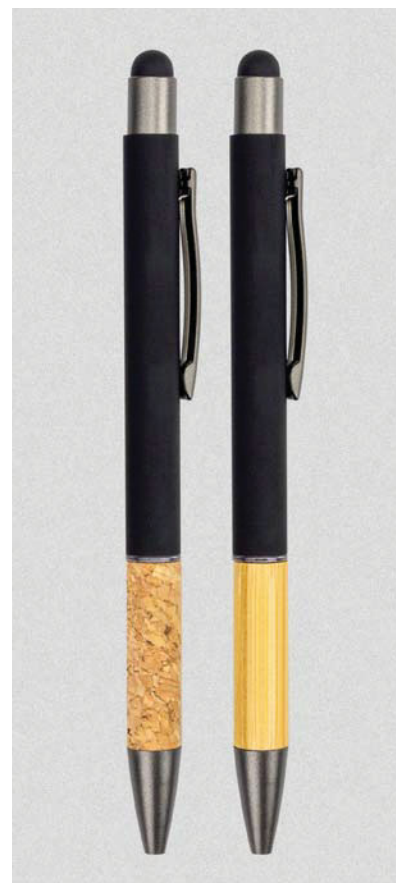

G0072
DŁUGOPIS METALOWY
AUTOMATYCZNY Z ELEMENTEM
KORKOWYM / automatic metal pen
with cork element

G0073
DŁUGOPIS METALOWY
AUTOMATYCZNY Z ELEMENTEM
BAMBUSOWYM / automatic metal pen
with bamboo element

wymiar / size

144 × 10 mm

pole graweru / engraving area

50 × 5 mm

inne / other

pokrycie soft, końcówka dotykowa,
wkład x-20 – 1 mm, kolor tuszu
niebieski, długość pisania około
1000 m / soft coating touch tip,
x-20 – 1 mm refill, blue ink colour,
writing length approximately 1000 m



TRÓJKĄTNA KIESZONKA Z FOLII /
triangular foil pocket

wymiar / size

80 × 80 mm
100 × 100 mm
120 × 120 mm



PROSTOKĄTNA KIESZONKA
Z FOLII / foil business card pocket

wymiar / size

90 × 60 mm

wymiar wizytówki /
business card size

≤ 85 × 55 mm



TASIEMKA SUBLIMACYJNA
(wg projektu) /sublimation ribbon
(according to design)

wymiar / size

8 mm
10 mm



druk / print

BARWIONE BRZEGI* / coloured edges

wymiar / size

pod każdy format / for any format

projekt barwienia brzegów / coloured edges design

autorski / customised

zamówienie / order

min. 100 szt. / MOQ 100 pcs.

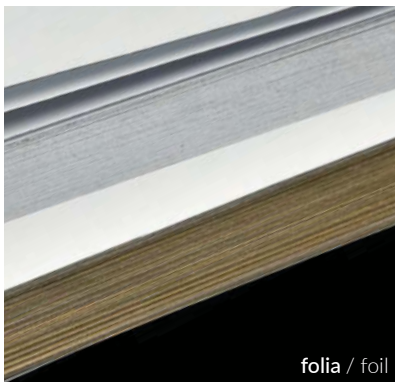

folia / foil



PERSONALIZACJA GRAWEROWANA
(wg projektu) / engraved personalisation
(according to design)

font rekomendowany /
recommended font

VERDANA Regular min. 14 pkt /
min. 14 pt Verdana Regular

* z wyłączeniem bloków z papieru z kamienia. możliwe barwienie brzegów przez druk wg CMYK, bądź uszlachetnienie folią złotą lub srebrną / possible colouring of the edges by printing in CMYK or finishing with gold or silver foil, excluding stone paper interiors

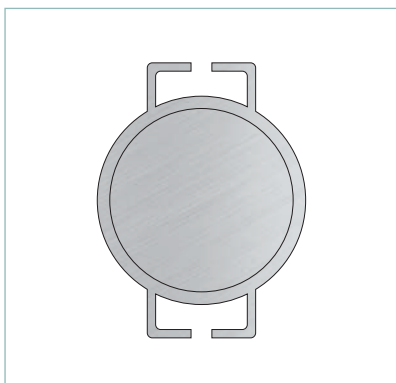
**M22** NEW

ZAWIESZKA METALOWA
POD NAKLEJKĘ EPOKSYDOWĄ
LUB NAKLEJKĘ METALICZNĄ
Z FINOCHROMEM, MOCOWANA
NA GUMCE 10 mm / metal plate with
epoxy or finochrome metal sticker
mounted on 10 mm elastic band

wymiar / size

33 × 25 mm

pole znakowania / marking area

21 × 21 mm

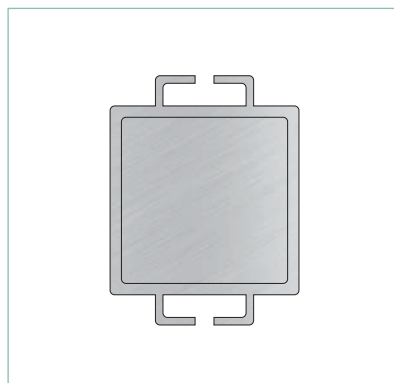
**M23** NEW

ZAWIESZKA METALOWA
POD NAKLEJKĘ EPOKSYDOWĄ
LUB NAKLEJKĘ METALICZNĄ
Z FINOCHROMEM, MOCOWANA
NA GUMCE 10 mm / metal plate with
epoxy or finochrome metal sticker
mounted on 10 mm elastic band

wymiar / size

33 × 25 mm

pole znakowania / marking area

22 × 22 mm

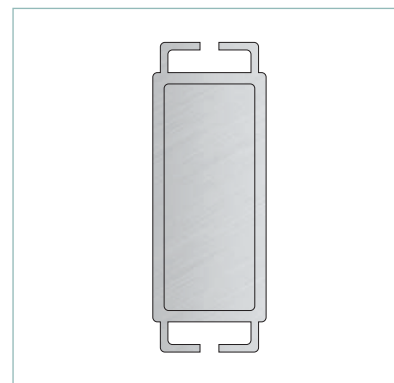
**M24** NEW

ZAWIESZKA METALOWA
POD NAKLEJKĘ EPOKSYDOWĄ
LUB NAKLEJKĘ METALICZNĄ
Z FINOCHROMEM, MOCOWANA
NA GUMCE 10 mm / metal plate with
epoxy or finochrome metal sticker
mounted on 10 mm elastic band

wymiar / size

41 × 15 mm

pole znakowania / marking area

31 × 12 mm

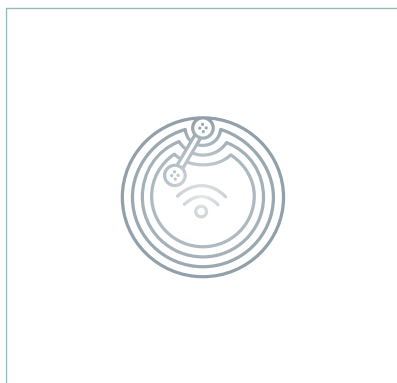
**NFC**

wymiar / size

30 × 30 mm

montaż / assembly

pod wyklejką / under the endpaper



**CHIP NFC - WGRAJ ODNOŚNIK DO SWOJEJ STRONY WWW!
WGRANE DANE SĄ ODCZYTYWANE PO ZBLIŻENIU TELEFONU. CHIP NFC
MOŻE BYĆ WKLEJANY NA TEKURZE POD WYKLEJKĄ, A INFORMACJA O NIM
W FORMIE NAKLEJKI LUB NADDRUKU NA WYKLEJCE.**

NFC chip: Share a link to your website!

Once the data is uploaded, it can be accessed when phone is nearby. The NFC chip can easily adhere to the cardboard beneath the endpaper, the information can be shown as a sticker or printed directly onto endpaper.



WKLEJKA WYCINANA AUTORSKA /
customised insert page

wymiar / size

pod każdy format / for any format

materiał / material

papier barwiony w masie /
mass dyed paper

papier kraftowy / kraft paper

znakowanie / marking method

druk / print

projekt / design

autorski / customised

**PAPIER KRAFT I BARWIONY W MASIE
DO KOPERT, WYKLEJEK, WKLEJEK
I OPAKOWAŃ** / kraft and mass dyed
paper for envelopes, endpapers, insert
pages and packaging

kraft

bordowy / maroon

magenta / magenta

czerwony / red

niebieski / blue

granatowy / dark blue

zielony / green

jasnozielony / light green

pomarańczowy / orange

żółty / yellow

szary / grey

czarny / black



KALKA / tracing paper

wymiar / size

pod każdy format / for any format

znakowanie / marking method

druk jednostronny (wg projektu) / one-sided printing (according to design)

zastosowanie / application

obwoluta, wklejka / banderole, insert page



WYCINANE REGISTRY /
cut-out registers

wg specyfikacji bloków /
according to block specifications

PROJEKT AUTORSKI / customised design



WYKLEJKA / endpaper



KOPERTA / envelope



WKLEJKA / insert page



BLOK AUTORSKI / customised interior

ŁĄCZENIE OPRAW / cover combinations

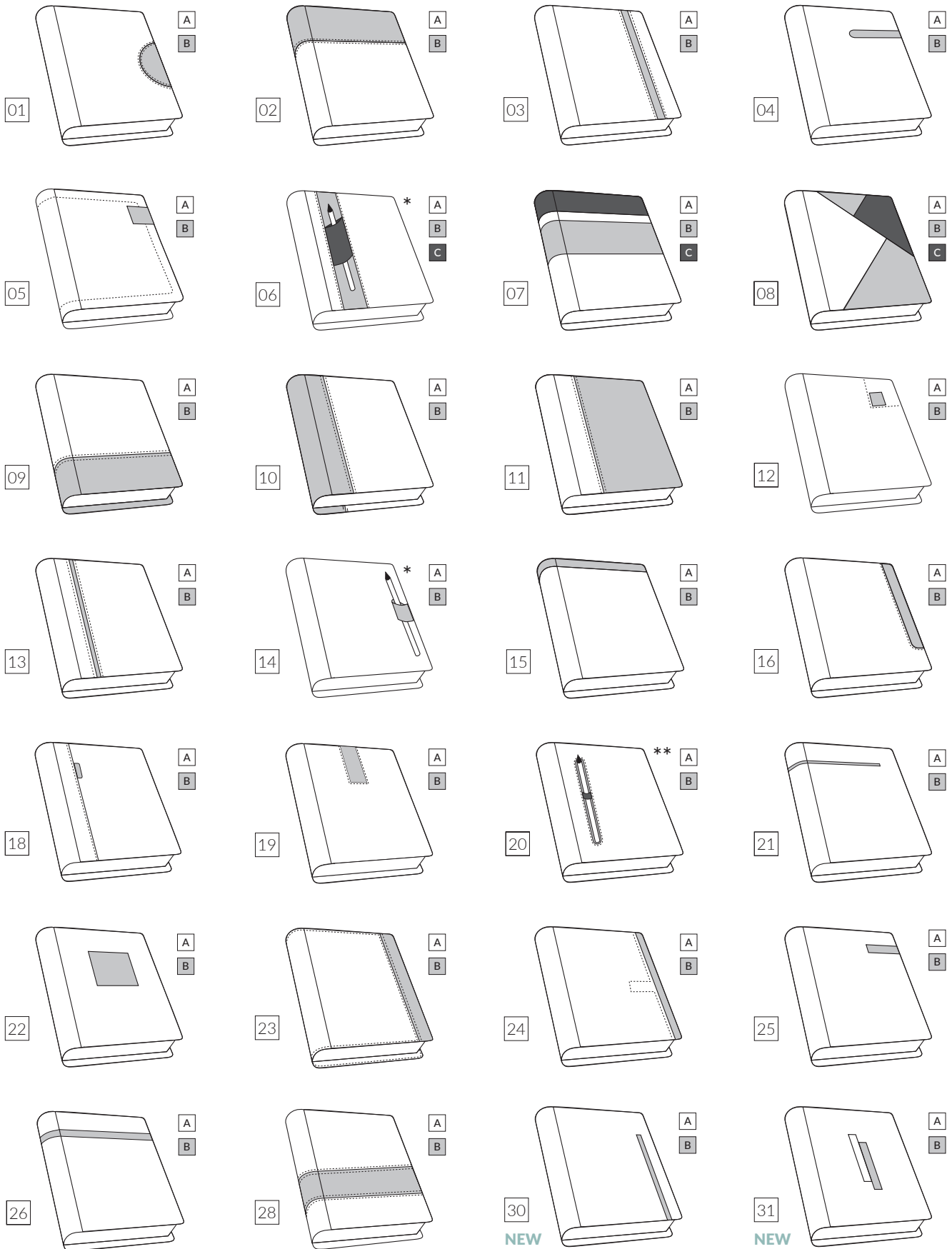

* szlufka na długopis z ekoskóry / elastic pen holder made of eco-leather ** szlufka na długopis z gumki / elastic pen holder made of elastic band

przedstawiona numeracja jest wykazem dostępnych łączeń opraw z wykluczeniem opraw papierowych i rpet / the numbering shown is the list of the cover combinations available, excluding paper and rpet covers

TYPY OPRAW / types of cover



OPRAWA NA TEKTURZE TWARDEJ 2 mm BEZ BIGU LUB Z BIGIEM, ROGI OKŁADKI ZAOKRĄGLONE / hard cover with or without bend, rounded corners of the cover



METALLIC PRINT – OPRAWA PAPIEROWA NA TEKTURZE TWARDEJ 2 mm BEZ BIGU, ROGI OPRAWY PROSTE / paper hard cover, without bend, straight corners of the cover



OPRAWA NA TEKTURZE Z PIAKĄ I Z BIGIEM, ROGI OKŁADKI ZAOKRĄGLONE / hard cover with foam and bend, rounded corners of the cover



FLEXI – KARTON ZAMIAST TEKSTURY, ROGI OKŁADKI ZAOKRĄGLONE, OBLIGATORYJNIE GUMKA NA OKŁADCE / different type of cardboard, rounded corners of the cover, mandatory elastic band

PROPOZYCJE ROKÓW / year design propositions

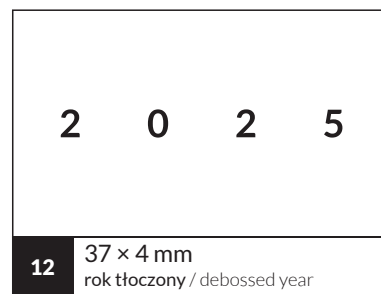
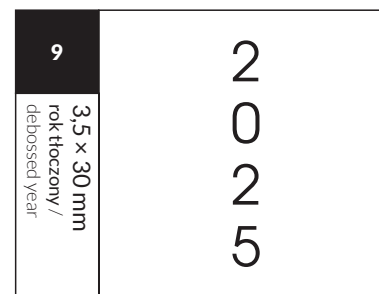
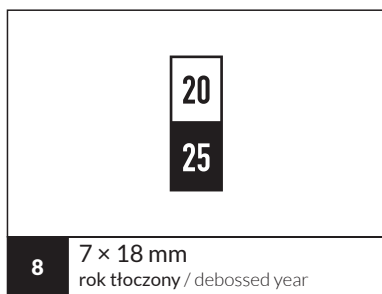
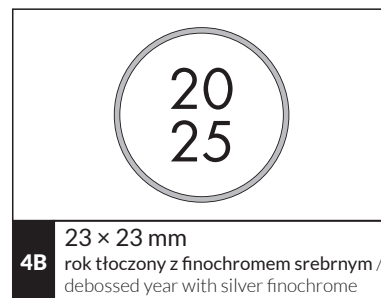
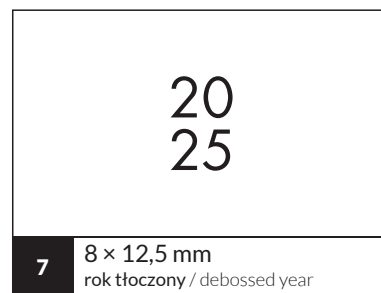
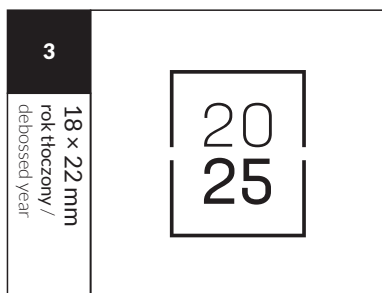

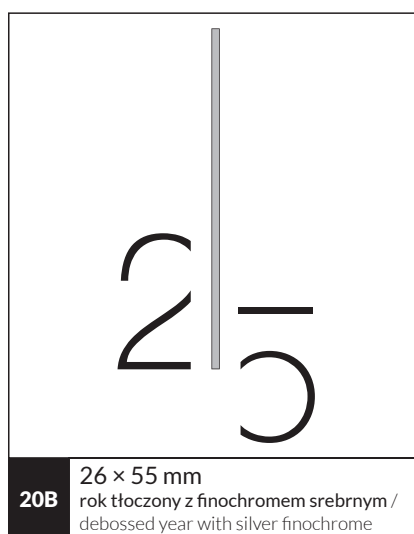
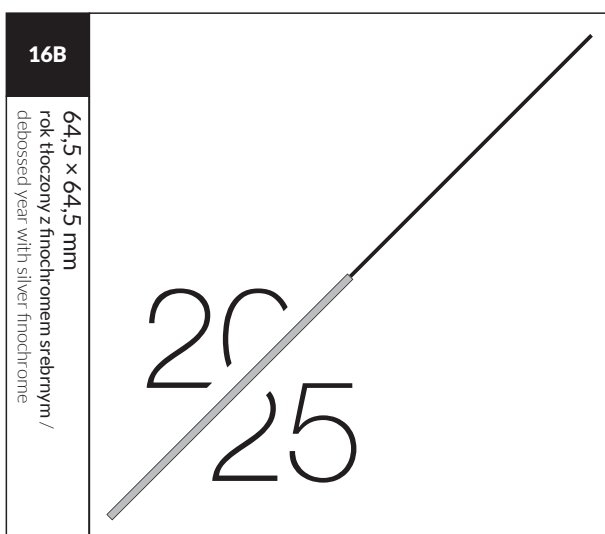
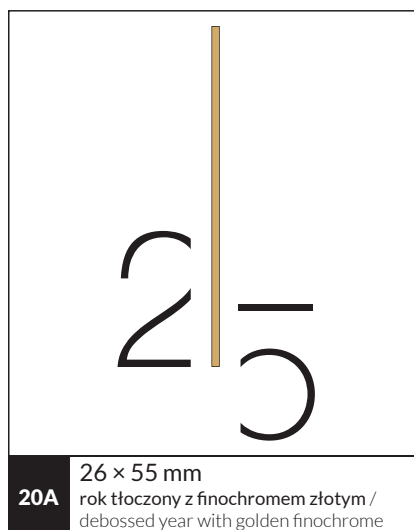
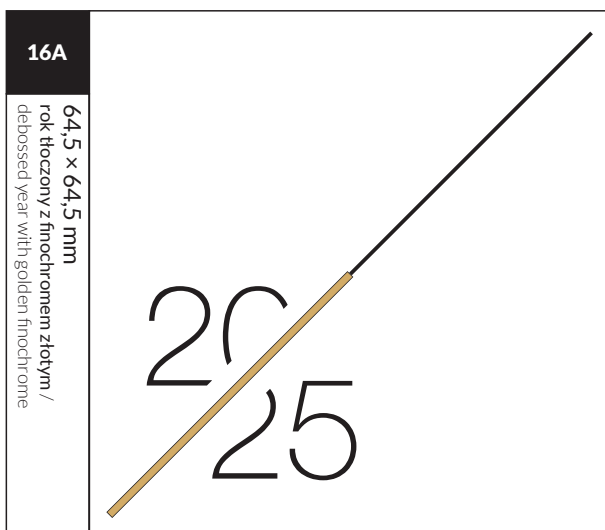
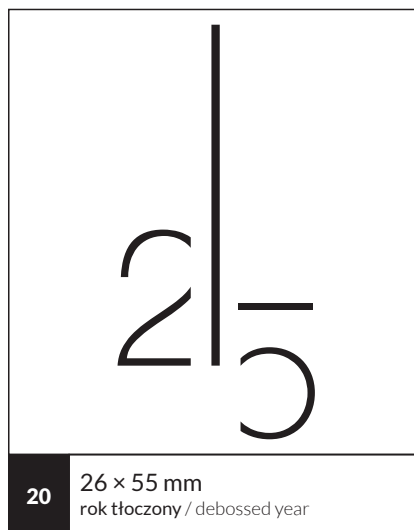
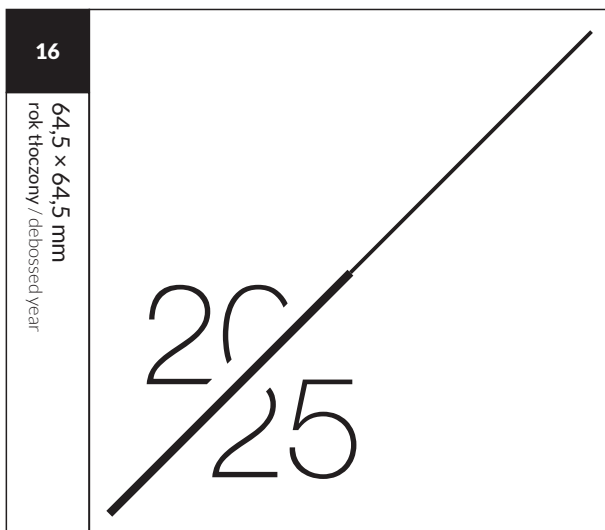

PROPOZYCJE ROKÓW / year design propositions

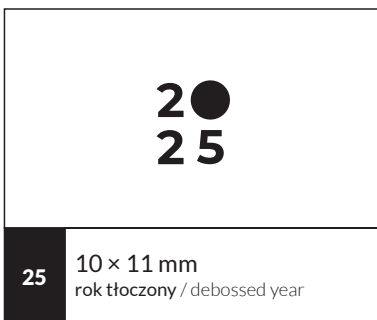
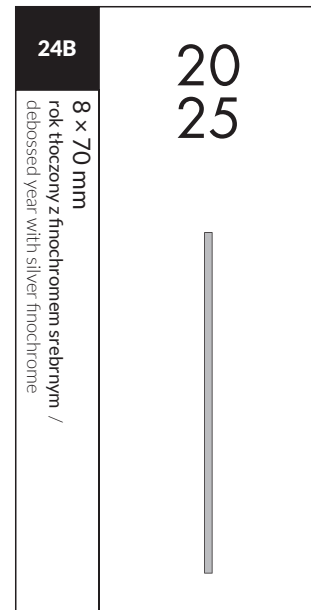
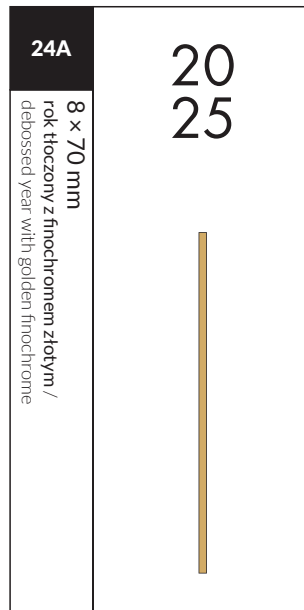
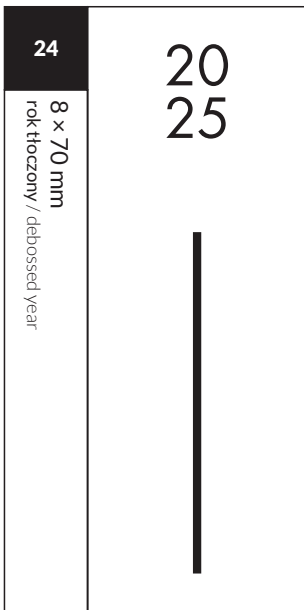
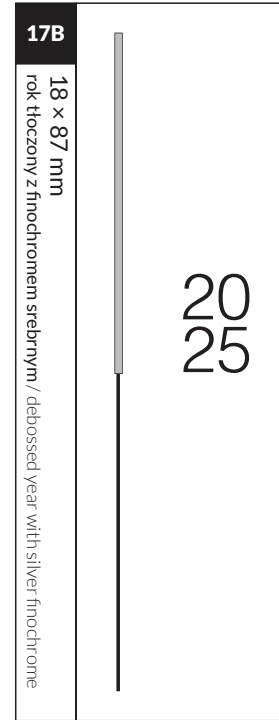
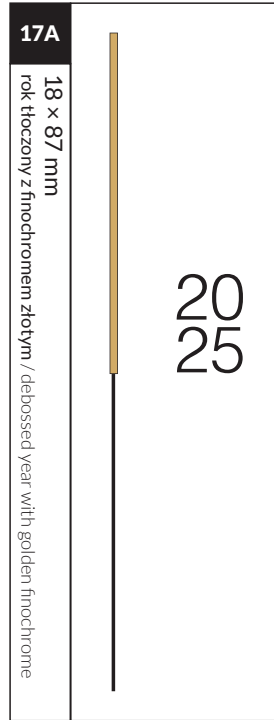
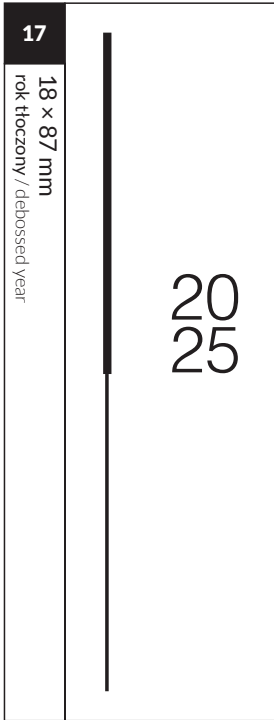

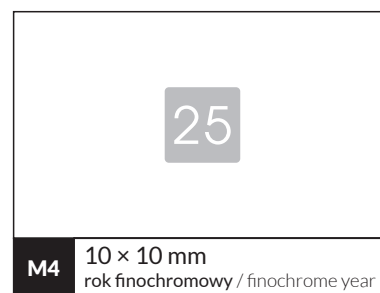
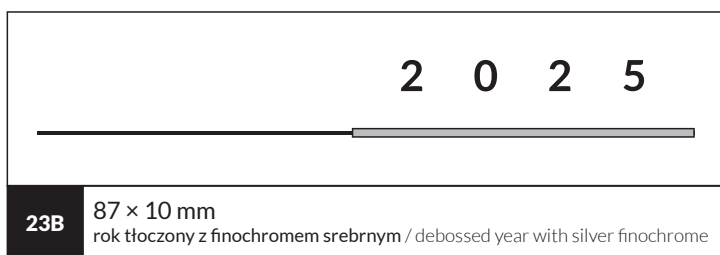
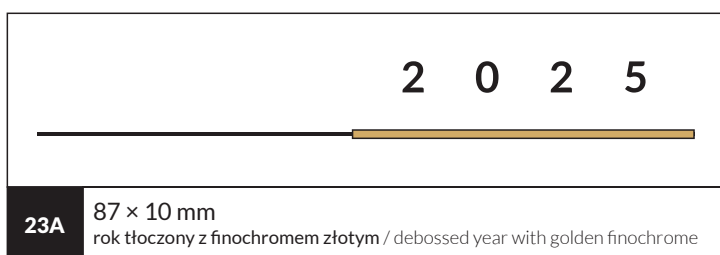
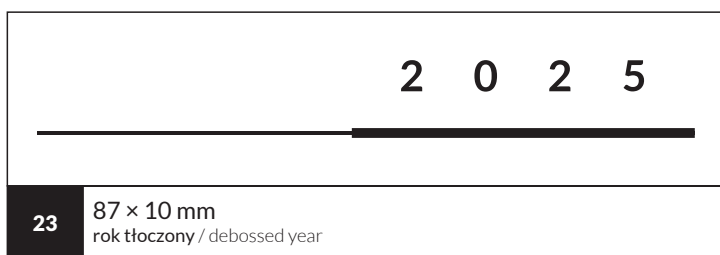
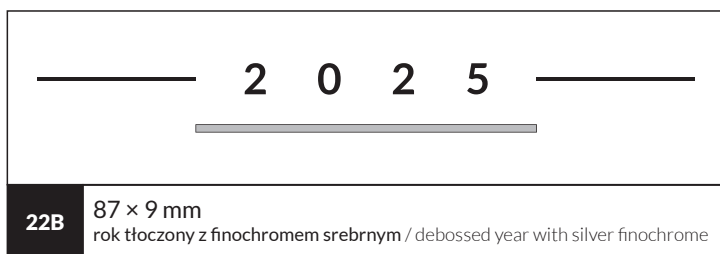
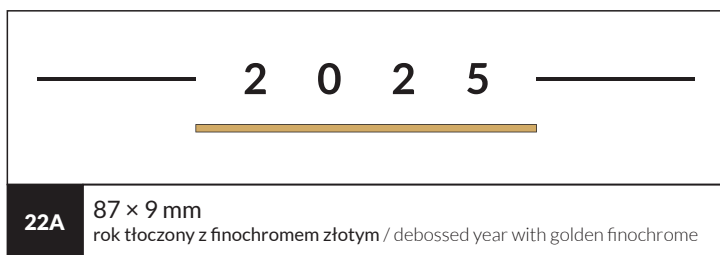
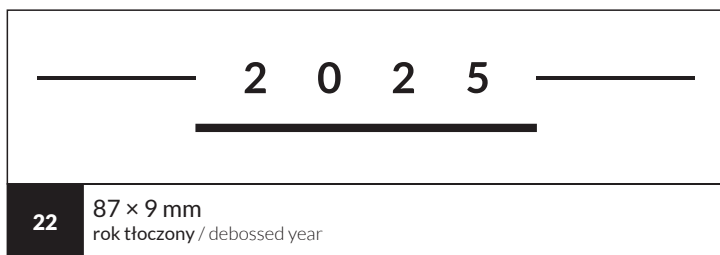

PROPOZYCJE ROKÓW / year design propositions

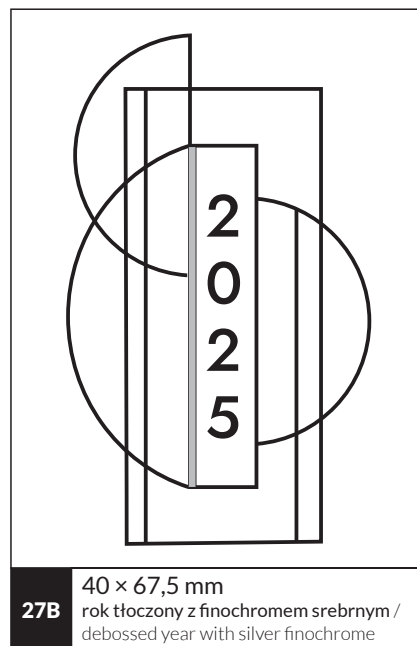
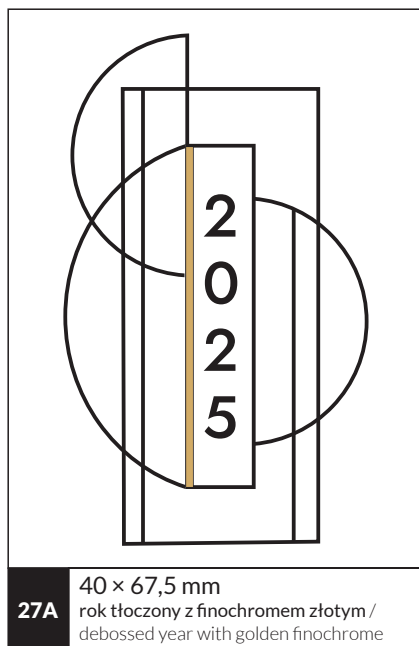
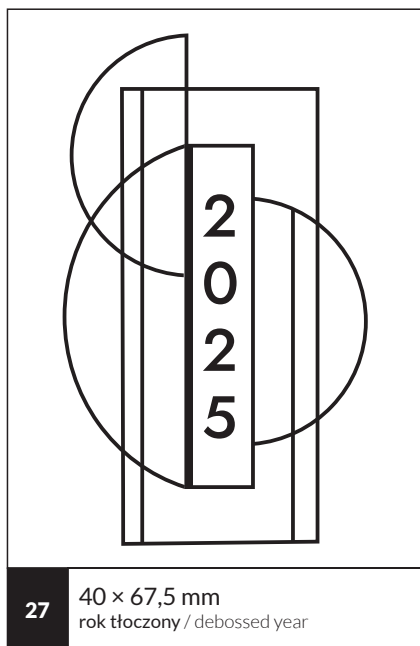
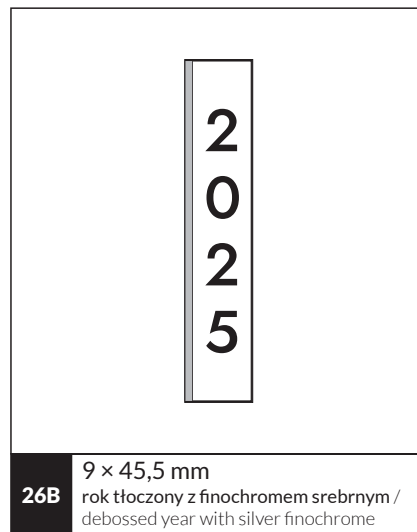
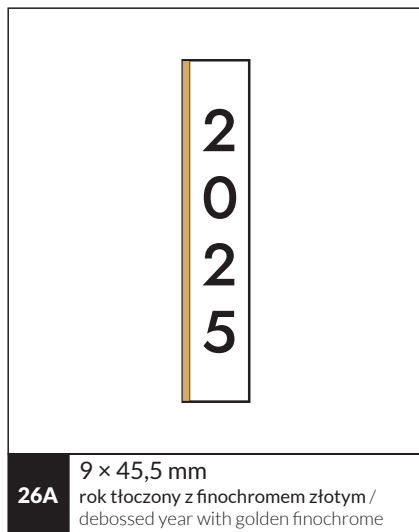
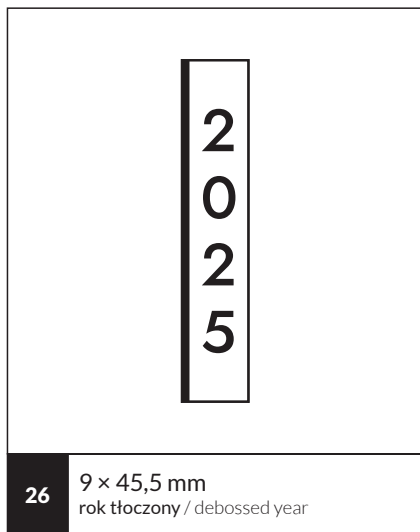

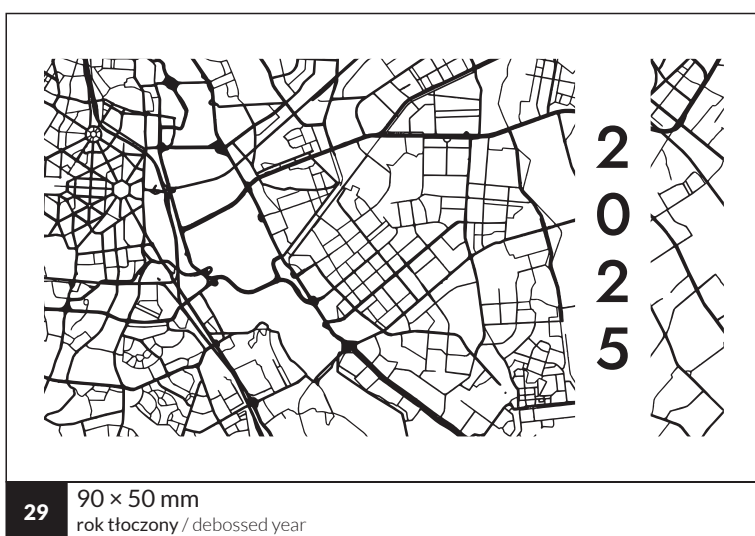
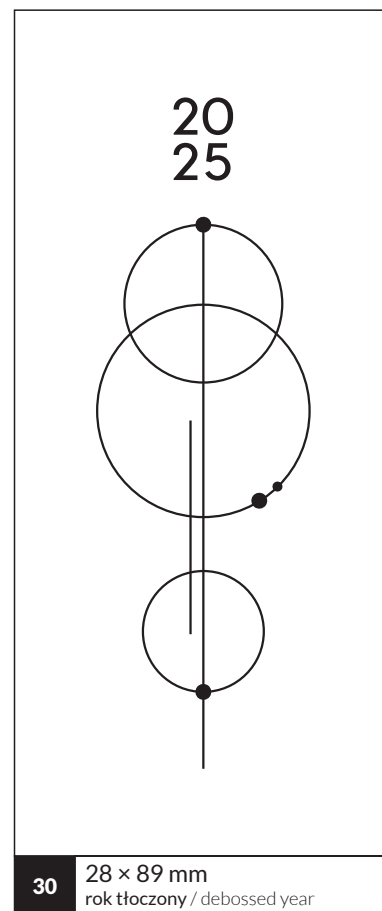
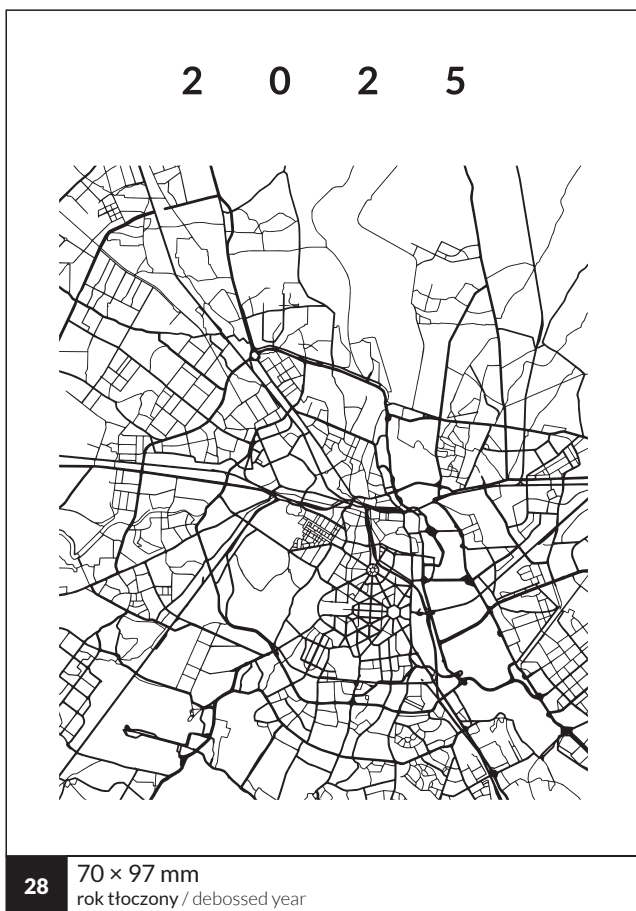

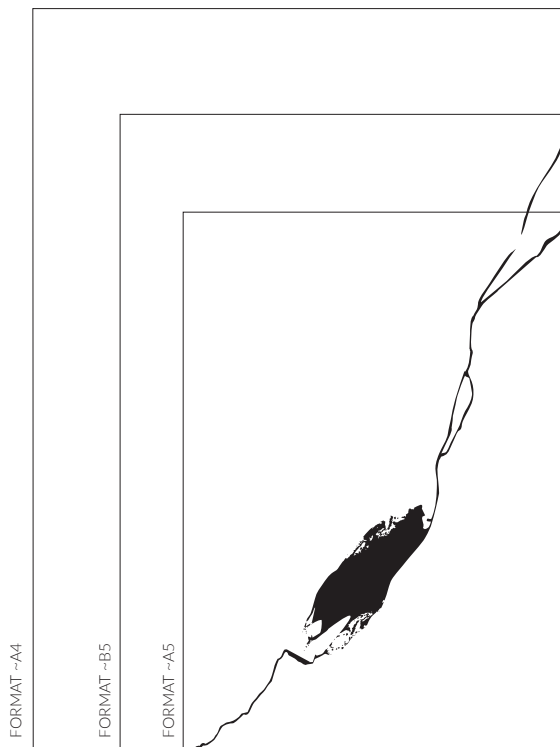

1 150 × 240 mm
wzór tłoczony / debossed pattern

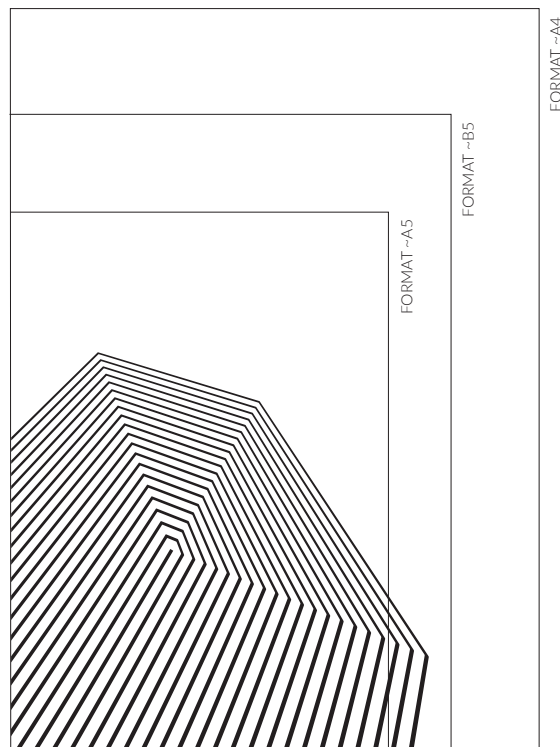

2 158 × 150 mm
wzór tłoczony / debossed pattern

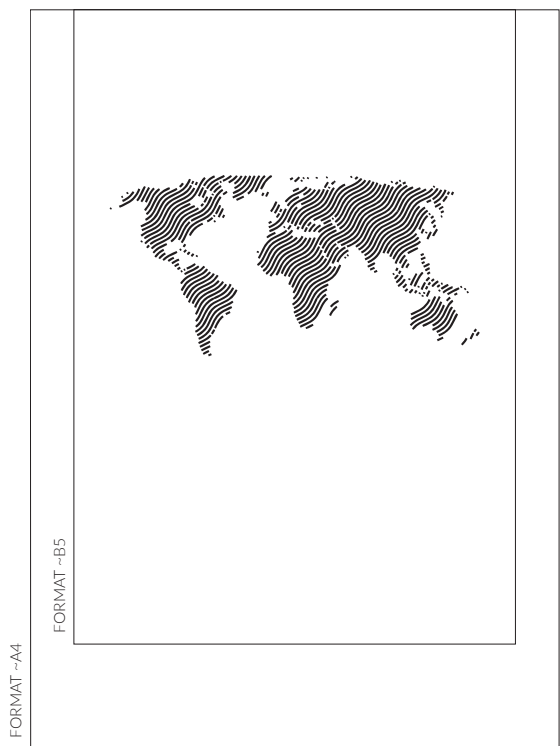

3 140 × 69 mm
wzór tłoczony / debossed pattern

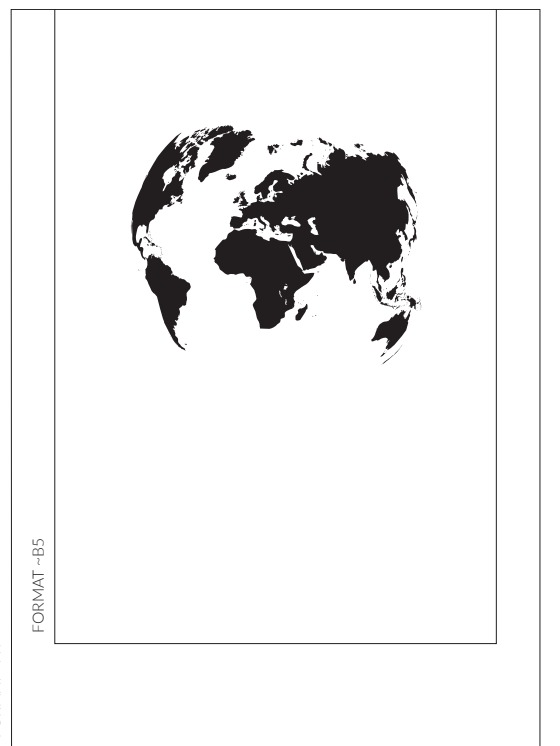

4 110 × 90 mm
wzór tłoczony / debossed pattern

MATRYCA DOSTOSOWANA DO FORMATU -A5 /
stamp adapted to -A5 format - 65 × 79 mm

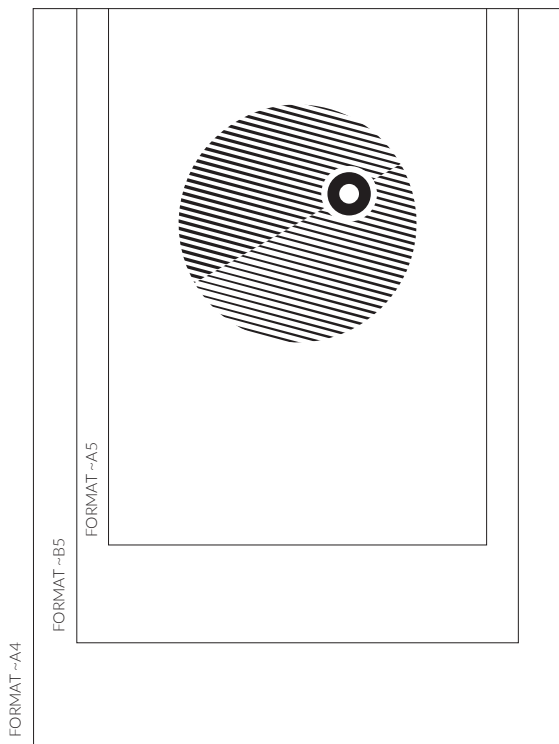

5

90 × 90 mm
wzór tłoczony / debossed pattern

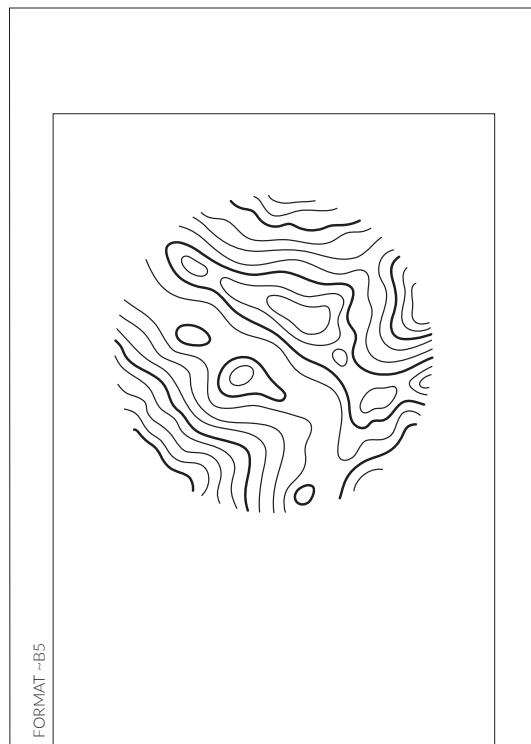

6

120 × 120 mm
wzór tłoczony / debossed pattern

MATRYCA DOSTOSOWANA DO FORMATU -A5 /
stamp adapted to -A5 format - 94 × 94 mm

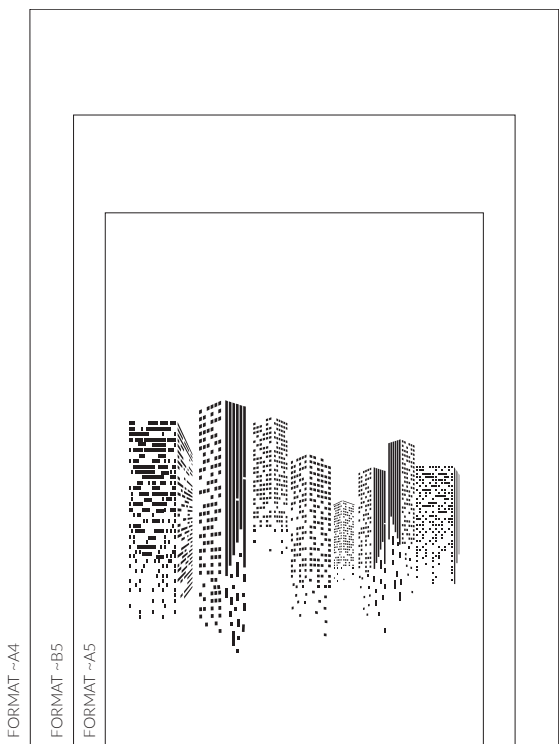

7

125 × 96 mm
wzór tłoczony / debossed pattern

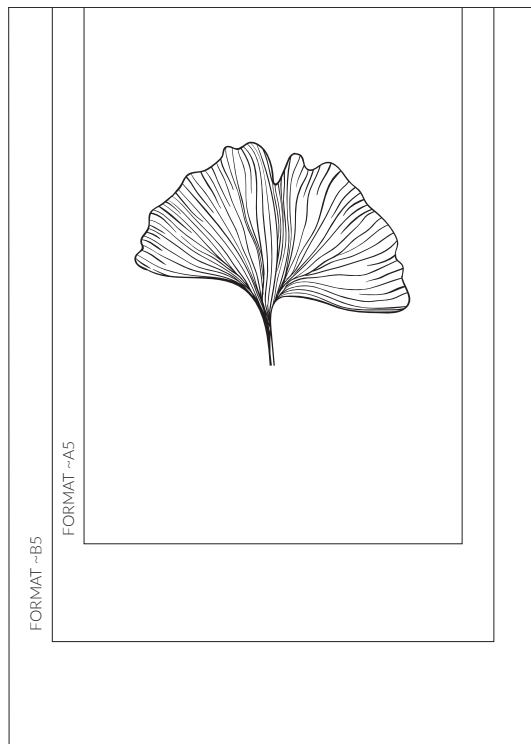

8

104 × 85 mm
wzór tłoczony / debossed pattern

prezentowane matryce do tłoczeń wielkoformatowych mogą zostać użyte bezpłatnie do dowolnego zamówienia. w takim przypadku klient ponosi koszt wyłącznie samej usługi tłoczenia zgodnie z obowiązującym cennikiem (bez kosztów matrycy) / presented stamps used for the large format debossings can be used free of charge for any order. in this case, the customer pays only for the cost of the debossing service in accordance with the applicable price list (without the costs of the stamp)

UKŁADY KALENDARZY DZIENNYCH / daily calendar layouts

501D 503D 508D

1-964

1 Środa

We / Mi / Me / Cp

STYCZEŃ
January, Januar, Gennaio, Січень

NOWY ROK
Mieczysława, Mieszka

TYDZIEŃ 1
Week, Woche, Settimana, Тиждень

7 _____

8 _____

9 _____

10 _____

11 _____

12 _____

13 _____

14 _____

15 _____

16 _____

17 _____

18 _____

19 _____

Siła, którą masz w sobie jest najlepszą wersją Ciebie.
Dzięki niej możesz stworzyć lepszy świat.
Ashley Rickards

	STYCZEŃ	LUTY	MARZEC	KWIECIEŃ	MAJ	CZERWIEC
T	1 2 3 4 5	5 6 7 8 9	9 10 11 12 13 14	14 15 16 17 18	18 19 20 21 22	22 23 24 25 26 27
W	6 13 20 27	3 10 17 24	3 10 17 24 31	7 14 21 28	5 12 19 26	2 9 16 23 30
WT	7 14 21 28	4 11 18 25	4 11 18 25	1 8 15 22 29	6 13 20 27	3 10 17 24
ŚR	1 8 15 22 29	5 12 19 26	5 12 19 26	2 9 16 23 30	7 14 21 28	4 11 18 25
CZ	2 9 16 23 30	6 13 20 27	6 13 20 27	3 10 17 24	1 8 15 22 29	5 12 19 26
PI	3 10 17 24 31	7 14 21 28	7 14 21 28	4 11 18 25	2 9 16 23 30	6 13 20 27
SO	4 11 18 25	1 8 15 22	1 8 15 22 29	5 12 19 26	3 10 17 24 31	7 14 21 28
ND	5 12 19 26	2 9 16 23	2 9 16 23 30	6 13 20 27	4 11 18 25	1 8 15 22 29

2+363

2 Czwartek

Th / Do / Gi / Чт

STYCZEŃ
January, Januar, Gennaio, Січень

Izydora, Makarego

TYDZIEŃ 1
Week, Woche, Settimana, Тиждень

7 _____

8 _____

9 _____

10 _____

11 _____

12 _____

13 _____

14 _____

15 _____

16 _____

17 _____

18 _____

19 _____

Jeśli jest w ogóle jakiś sekret sukcesu, leży on w umiejętności
przyjęcia punktu widzenia innych i patrzaniu na rzeczy zarówno
z perspektywy rozmówcy, jak i własnej.
Henry Ford

	LIPIEC	SIERPIEŃ	WRZESIEŃ	PAŹDZIERNIK	LISTOPAD	GRUDZIEŃ
T	27 28 29 30 31	31 32 33 34 35	30 31 32 33 34 35	40 41 42 43 44	44 45 46 47 48	49 50 51 52 1
W	7 14 21 28	4 11 18 25	1 8 15 22 29	6 13 20 27	3 10 17 24	1 8 15 22 29
WT	1 8 15 22 29	5 12 19 26	2 9 16 23 30	7 14 21 28	4 11 18 25	2 9 16 23 30
ŚR	2 9 16 23 30	6 13 20 27	3 10 17 24	1 8 15 22 29	5 12 19 26	3 10 17 24 31
CZ	3 10 17 24 31	7 14 21 28	4 11 18 25	2 9 16 23 30	6 13 20 27	4 11 18 25
PI	4 11 18 25	1 8 15 22 29	5 12 19 26	3 10 17 24 31	7 14 21 28	5 12 19 26
SO	5 12 19 26	2 9 16 23 30	6 13 20 27	4 11 18 25	1 8 15 22 29	6 13 20 27
ND	6 13 20 27	3 10 17 24 31	7 14 21 28	5 12 19 26	2 9 16 23 30	7 14 21 28

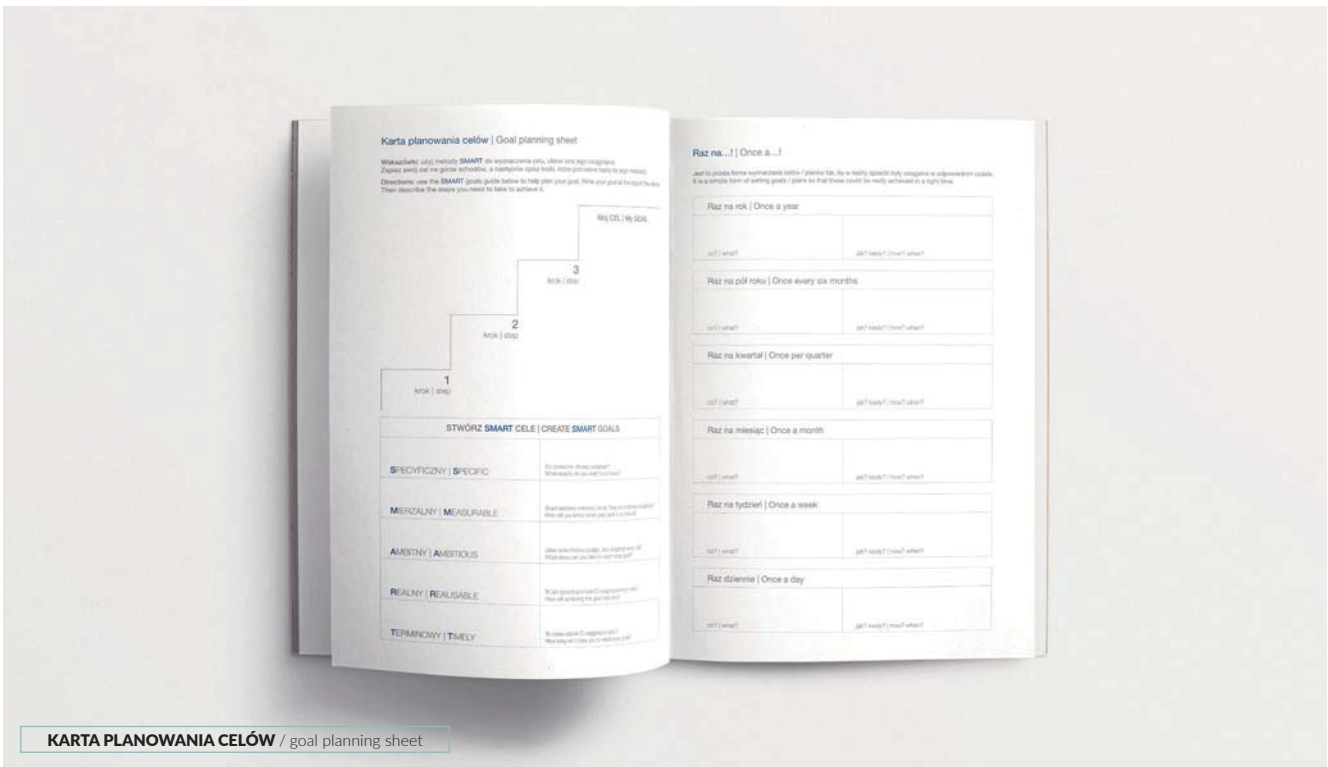

KARTA PLANOWANIA CELÓW / goal planning sheet

KALENDARZ / calendar		501D	503D	508D	REGISTRY / index		perforacja narożników corner perforation
format / format		200 × 280 mm ~A4	143 × 203 mm ~A5	162 × 240 mm ~B5	drukowane printed	wycinane cut-out	
ilość stron / pages		368	368	368			
papier biały / white paper druk / print	szaro-bordowy grey-maroon	✓	✓	✓	✓	✓	✓
	szaro-granatowy grey-dark blue	✓	✓	✓	✓	✓	✓
	grafitowy graphite						
papier chamois / ivory paper druk / print	szaro-bordowy grey-maroon	✓	✓	✓	✓	✓	✓
	szaro-granatowy grey-dark blue	✓	✓	✓	✓	✓	✓
	grafitowy graphite						
papier z recyklingu / recycled paper druk / print	grafitowy graphite		✓		✓		
papier z trawy / grass paper druk / print	grafitowy graphite						
papier z kamienia / stone paper druk / print	grafitowy graphite						
język / language		PL GB DE IT UA					
dane personalne / personal data		✓	✓	✓			
licznik dni / day counter		✓	✓	✓			
numeracja tygodni / week numbering		✓	✓	✓			
karta planowania celów / goal planning sheet		✓	✓	✓			
święta międzynarodowe / international holidays		✓	✓	✓			
kalendarz skrócony / shortened calendar 2024-2026		✓	✓	✓			
plan urlopowy / vacation plan 2025		✓	✓	✓			
planer roczny / annual planner		✓	✓	✓			
planer miesięczny / monthly planner		✓	✓	✓			
kalendarz roczny / annual calendar 2025		✓	✓	✓			
imieniny / name day		✓	✓	✓			
aforyzmy / aphorisms		✓	✓	✓			
oświadczenie drogowe / road accident statement		✓	✓	✓			
notes / notebook		✓	✓	✓			
mapy / maps							

506D

314-51

10 **Poniedziałek** **LISTOPAD**
Mo / Mo / Lu / Plu November, November, Novembre, Листопад

TYDZIEŃ 46
Lety, Ludomira Week, Woche, Settimana, Тиждень

7 _____

8 _____

9 _____

10 _____

11 _____

12 _____

13 _____

14 _____

15 _____

16 _____

17 _____

18 _____

19 _____

LISTOPAD
T PN WT ŚR CZ PT SO ND
44 _____ **1 2**
45 3 4 5 6 7 8 9
46 10 11 12 13 14 15 16
47 17 18 19 20 21 22 23
48 24 25 26 27 28 29 30

Człowiek bardzo się uskarża przy każdym bólu,
a tak rzadko się cieszy, gdy go nie czuje.
Georg Lichtenberg

315-50

11 **Wtorek** **LISTOPAD**
Tu / Di / Ma / Br November, November, Novembre, Листопад

TYDZIEŃ 46
Bartłomeja, Marcina Week, Woche, Settimana, Тиждень

7 _____

8 _____

9 _____

10 _____

11 _____

12 _____

13 _____

14 _____

15 _____

16 _____

17 _____

18 _____

19 _____

GRUDZIEŃ
T PN WT ŚR CZ PT SO ND
49 1 2 3 4 5 6 7
50 8 9 10 11 12 13 14
51 15 16 17 18 19 20 21
52 22 23 24 25 26 27 28
1 29 30 31

Życie jest długie i nudne, jeśli nie przeżywa się go tak,
jakby się chciało.
Laurent Guinelle

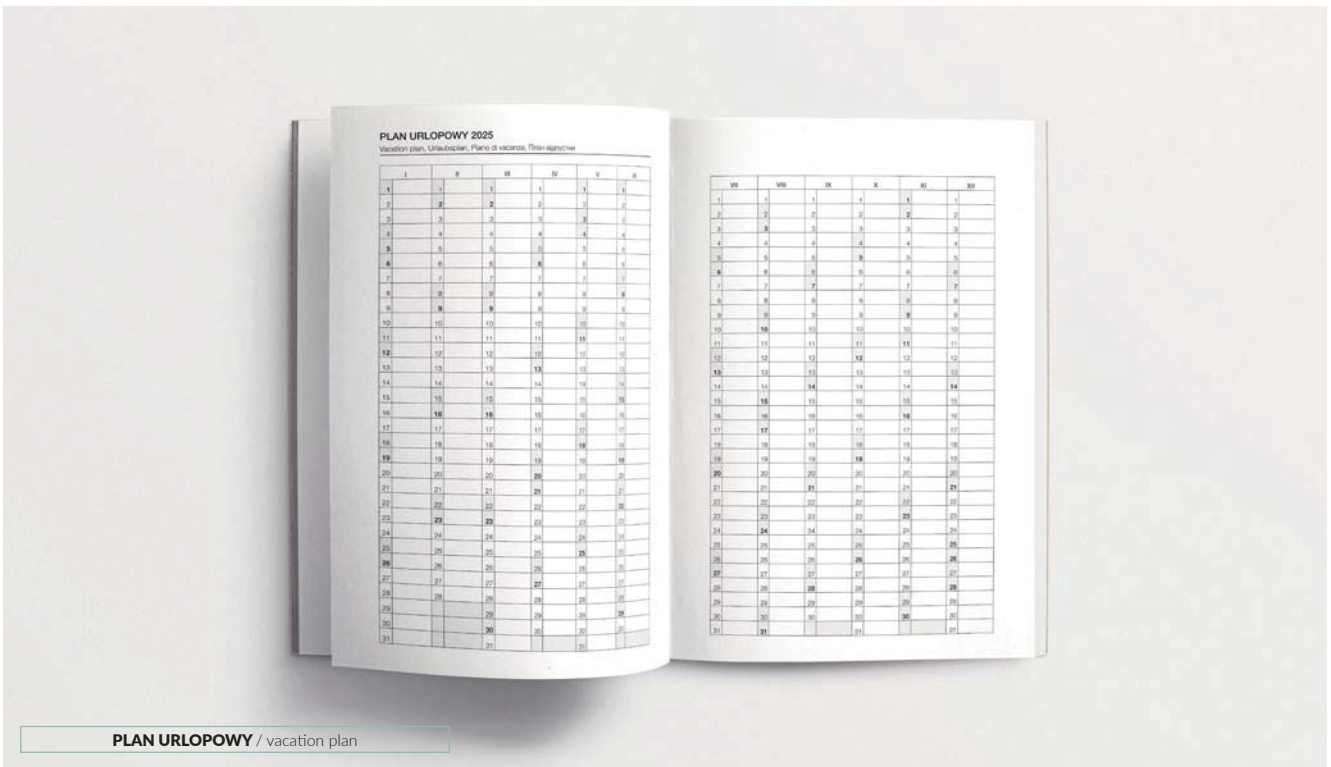

PLAN URLOPOWY / vacation plan

KALENDARZ / calendar		506D	REGISTRY / index		perforacja narożników corner perforation
format / format		110 × 160 mm ~A6	drukowane printed	wycinane cut-out	
ilość stron / pages		368			
papier biały / white paper druk / print	szaro-bordowy grey-maroon				
	szaro-granatowy grey-dark blue				
	grafitowy graphite	✓	✓		
papier chamois / ivory paper druk / print	szaro-bordowy grey-maroon				
	szaro-granatowy grey-dark blue				
	grafitowy graphite				
papier z recyklingu / recycled paper druk / print	grafitowy graphite				
papier z trawy / grass paper druk / print	grafitowy graphite				
papier z kamienia / stone paper druk / print	grafitowy graphite				
język / language		PL GB DE IT UA			
dane personalne / personal data		✓			
licznik dni / day counter		✓			
numeracja tygodni / week numbering		✓			
karta planowania celów / goal planning sheet		✓			
święta międzynarodowe / international holidays		✓			
kalendarz skrócony / shortened calendar 2024-2026		✓			
plan urlopowy / vacation plan 2025		✓			
planer roczny / annual planner					
planer miesięczny / monthly planner		✓			
kalendarz roczny / annual calendar 2025		✓			
imieniny / name day		✓			
aforyzmy / aphorisms		✓			
oświadczenie drogowe / road accident statement					
notes / notebook		✓			
mapy / maps					

KALENDARZ / calendar		510D	REGISTRY / index		perforacja narożników corner perforation
format / format		143 × 203 mm ~A5	drukowane printed	wycinane cut-out	
ilość stron / pages		368			
papier biały / white paper druk / print	szaro-bordowy grey-maroon				
	szaro-granatowy grey-dark blue				
	grafitowy graphite	✓	✓		
papier chamois / ivory paper druk / print	szaro-bordowy grey-maroon				
	szaro-granatowy grey-dark blue				
	grafitowy graphite				
papier z recyklingu / recycled paper druk / print	grafitowy graphite				
papier z trawy / grass paper druk / print	grafitowy graphite				
papier z kamienia / stone paper druk / print	grafitowy graphite				
język / language		GB			
dane personalne / personal data		✓			
licznik dni / day counter		✓			
numeracja tygodni / week numbering		✓			
karta planowania celów / goal planning sheet		✓			
święta międzynarodowe / international holidays		✓			
kalendarz skrócony / shortened calendar 2024-2026		✓			
plan urlopowy / vacation plan 2025					
planer roczny / annual planner		✓			
planer miesięczny / monthly planner		✓			
kalendarz roczny / annual calendar 2025		✓			
imieniny / name day					
aforyzmy / aphorisms					
oświadczenie drogowe / road accident statement					
notes / notebook		✓			
mapy / maps					

UKŁADY KALENDARZY TYGODNIOWYCH / weekly calendar layouts

502T 507T

KWIECIEŃ
April, April, Aprile, Kairany.

111+254
21 | **Poniedziałek**
Mo / Mo / Lu / Dh

112+253
22 | **Wtorek**
Tu / Di / Ma / Br

113+252
23 | **Środa**
We / Mi / Me / Co

PONIEDZIAŁEK WIELKANOCNY
Felixsa, Anzelmia

DZIEŃ ZIEMI
Leona, Lukasz

Jerzego, Wojciecha

7 _____

8 _____

9 _____

10 _____

11 _____

12 _____

13 _____

14 _____

15 _____

16 _____

17 _____

18 _____

TYDZIEŃ 17
Week, Woche, Settimana, Тиждень.

114+251
24 | **Czwartek**
Th / Do / Gi / Hr

115+250
25 | **Piątek**
Fr / Fr / Ve / Fr

116+249
26 | **Sobota**
Sa / Sa / Sa / Co

Grzegorza, Aleksandra

Marka, Jarosława

Marzeny, Marcjego

7 _____

8 _____

9 _____

10 _____

11 _____

12 _____

13 _____

14 _____

15 _____

16 _____

17 _____

18 _____

117+248
27 | **Niedziela**
Su / So / Do / Hn

Zyty, Teofila

Odwaga to robienie tego, co bosisz się zrobić. Nie możemy mówić o odwadze, w przypadku, gdy nie jesteś przeciwnikiem.

Edyta Rockenbauer

	STYCZEŃ	LUTY	MARZEC	KWIECIEŃ	MAJ	CZERWIEC
T	1 2 3 4 5	3 6 7 8 9	9 10 11 12 13 14	14 12 16 17 18	16 19 20 21 22	22 23 24 25 26 27
We	6 13 20 27	3 10 17 24	3 10 17 24 31	7 14 21 28	5 12 19 26	2 9 16 23 30
Pi	7 14 21 28	4 11 18 25	4 11 18 25	1 8 15 22 29	6 13 20 27	3 10 17 24
So	1 8 15 22 29	5 12 19 26	5 12 19 26	2 9 16 23 30	7 14 21 28	4 11 18 25
Cz	2 9 16 23 30	6 13 20 27	6 13 20 27	3 10 17 24	1 8 15 22 29	5 12 19 26
Wt	3 10 17 24 31	7 14 21 28	7 14 21 28	4 11 18 25	2 9 16 23 30	6 13 20 27
Śr	4 11 18 25	1 8 15 22	1 8 15 22 29	5 12 19 26	3 10 17 24 31	7 14 21 28
Nd	5 12 19 26	2 9 16 23	2 9 16 23 30	6 13 20 27	4 11 18 25	1 8 15 22 29

	LIPIEC	SIERPIEŃ	WRZEŚIEŃ	PAŹDZIERNIK	LISTOPAD	GRUDZIEŃ
T	27 28 29 30 31	31 02 03 04 05	36 37 38 39 40	40 41 42 43 44	44 45 46 47 48	49 50 51 52 1
Wt	7 14 21 28	4 11 18 25	1 8 15 22 29	6 13 20 27	3 10 17 24	1 8 15 22 29
Pi	1 8 15 22 29	5 12 19 26	2 9 16 23 30	7 14 21 28	4 11 18 25	2 9 16 23 30
So	2 9 16 23 30	6 13 20 27	3 10 17 24	1 8 15 22 29	5 12 19 26	3 10 17 24 31
Cz	3 10 17 24 31	7 14 21 28	4 11 18 25	2 9 16 23 30	6 13 20 27	4 11 18 25
Wt	4 11 18 25	1 8 15 22 29	5 12 19 26	3 10 17 24 31	7 14 21 28	5 12 19 26
Śr	5 12 19 26	2 9 16 23 30	6 13 20 27	4 11 18 25	1 8 15 22 29	6 13 20 27
Nd	6 13 20 27	3 10 17 24 31	7 14 21 28	5 12 19 26	2 9 16 23 30	7 14 21 28



PLANER ROCZNY / annual planner

KALENDARZ / calendar		502T	507T	REGISTRY / index		perforacja narożników corner perforation
format / format		208 × 260 mm ~A4	167 × 240 mm ~B5	drukowane printed	wycinane cut-out	
ilość stron / pages		160	160			
papier biały / white paper druk / print	szaro-bordowy grey-maroon	✓	✓	✓	✓	✓
	szaro-granatowy grey-dark blue	✓	✓	✓	✓	✓
	grafitowy graphite					
papier chamois / ivory paper druk / print	szaro-bordowy grey-maroon	✓	✓	✓	✓	✓
	szaro-granatowy grey-dark blue	✓	✓	✓	✓	✓
	grafitowy graphite					
papier z recyklingu / recycled paper druk / print	grafitowy graphite					
papier z trawy / grass paper druk / print	grafitowy graphite		✓	✓		
papier z kamienia / stone paper druk / print	grafitowy graphite					
język / language		PL GB DE IT UA				
dane personalne / personal data		✓	✓			
licznik dni / day counter		✓	✓			
numeracja tygodni / week numbering		✓	✓			
karta planowania celów / goal planning sheet		✓	✓			
święta międzynarodowe / international holidays		✓	✓			
kalendarz skrócony / shortened calendar 2024-2026		✓	✓			
plan urlopowy / vacation plan 2025		✓	✓			
planer roczny / annual planner		✓	✓			
planer miesięczny / monthly planner		✓	✓			
kalendarz roczny / annual calendar 2025		✓	✓			
imieniny / name day		✓	✓			
aforyzmy / aphorisms		✓	✓			
oświadczenie drogowe / road accident statement		✓	✓			
notes / notebook		✓	✓			
mapy / maps						

KALENDARZ / calendar		504T	REGISTRY / index		perforacja narożników corner perforation
format / format		84 × 151 mm format kieszonkowy pocket-sized format	drukowane printed	wycinane cut-out	
ilość stron / pages		128			
papier biały / white paper druk / print	szaro-bordowy grey-maroon				
	szaro-granatowy grey-dark blue				
	grafitowy graphite	✓	✓		
papier chamois / ivory paper druk / print	szaro-bordowy grey-maroon				
	szaro-granatowy grey-dark blue				
	grafitowy graphite	✓	✓		
papier z recyklingu / recycled paper druk / print	grafitowy graphite				
papier z trawy / grass paper druk / print	grafitowy graphite				
papier z kamienia / stone paper druk / print	grafitowy graphite				
język / language		PL GB DE IT UA			
dane personalne / personal data		✓			
licznik dni / day counter					
numeracja tygodni / week numbering		✓			
karta planowania celów / goal planning sheet					
święta międzynarodowe / international holidays		✓			
kalendarz skrócony / shortened calendar 2024-2026		✓			
plan urlopowy / vacation plan 2025					
planer roczny / annual planner					
planer miesięczny / monthly planner					
kalendarz roczny / annual calendar 2025					
imieniny / name day		✓			
aforyzmy / aphorisms					
oświadczenie drogowe / road accident statement					
notes / notebook		✓			
mapy / maps					

KALENDARZ / calendar		509T	511T	512T	REGISTRY / index		perforacja narożników corner perforation
format / format		149 × 203 mm ~A5	208 × 260 mm ~A4	167 × 240 mm ~B5	drukowane printed	wycinane cut-out	
ilość stron / pages		160	160	160			
papier biały / white paper druk / print	szaro-bordowy grey-maroon						
	szaro-granatowy grey-dark blue						
	grafitowy graphite	✓	✓	✓			
papier chamois / ivory paper druk / print	szaro-bordowy grey-maroon						
	szaro-granatowy grey-dark blue						
	grafitowy graphite	✓		✓			
papier z recyklingu / recycled paper druk / print	grafitowy graphite	✓		✓			
papier z trawy / grass paper druk / print	grafitowy graphite	✓	✓	✓			
papier z kamienia / stone paper druk / print	grafitowy graphite	✓	✓	✓			
język / language		PL GB DE IT UA					
dane personalne / personal data		✓	✓	✓			
licznik dni / day counter							
numeracja tygodni / week numbering		✓	✓	✓			
karta planowania celów / goal planning sheet		✓	✓	✓			
święta międzynarodowe / international holidays		✓	✓	✓			
kalendarz skrócony / shortened calendar 2024-2026		✓	✓	✓			
plan urlopowy / vacation plan 2025		✓	✓	✓			
planer roczny / annual planner		✓	✓	✓			
planer miesięczny / monthly planner		✓	✓	✓			
kalendarz roczny / annual calendar 2025							
imieniny / name day		✓	✓	✓			
aforyzmy / aphorisms		✓	✓	✓			
oświadczenie drogowe / road accident statement		✓	✓	✓			
notes / notebook		✓	✓	✓			
mapy / maps							

UKŁADY KALENDARZY TYGODNIOWYCH / weekly calendar layouts

514T - WERSJA MIĘDZYNARODOWA / international version

DECEMBER	Week 52	
22 Monday		
23 Tuesday		
24 Wednesday		
25 Thursday		
26 Friday		
27 Saturday		28 Sunday

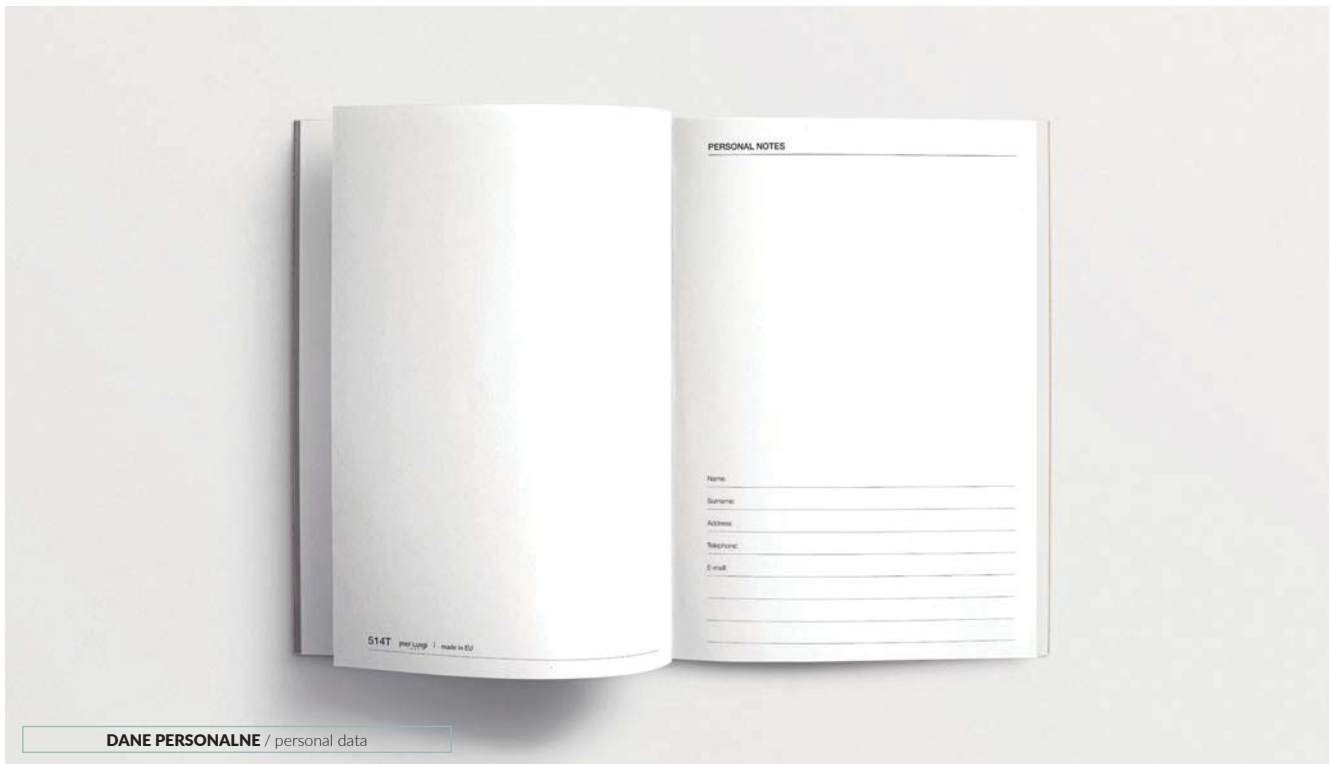

DANE PERSONALNE / personal data

KALENDARZ / calendar		514T	REGISTRY / index		perforacja narożników corner perforation
format / format		167 × 240 mm ~B5	drukowane printed	wycinane cut-out	
ilość stron / pages		160			
papier biały / white paper druk / print	szaro-bordowy grey-maroon				
	szaro-granatowy grey-dark blue				
	grafitowy graphite	✓			
papier chamois / ivory paper druk / print	szaro-bordowy grey-maroon				
	szaro-granatowy grey-dark blue				
	grafitowy graphite				
papier z recyklingu / recycled paper druk / print	grafitowy graphite				
papier z trawy / grass paper druk / print	grafitowy graphite				
papier z kamienia / stone paper druk / print	grafitowy graphite				
język / language		GB			
dane personalne / personal data		✓			
licznik dni / day counter					
numeracja tygodni / week numbering		✓			
karta planowania celów / goal planning sheet		✓			
święta międzynarodowe / international holidays		✓			
kalendarz skrócony / shortened calendar 2024-2026		✓			
plan urlopowy / vacation plan 2025					
planer roczny / annual planner		✓			
planer miesięczny / monthly planner		✓			
kalendarz roczny / annual calendar 2025					
imieniny / name day					
aforyzmy / aphorisms					
oświadczenie drogowe / road accident statement					
notes / notebook		✓			
mapy / maps					

UKŁAD PLANERA / planner layout

516 - WERSJA MIĘDZYNARODOWA / international version



PLANER / planner		516	REGISTRY / index		perforacja narożników corner perforation
format / format		167 × 240 mm ~B5	drukowane printed	wycinane cut-out	
ilość stron / pages		160			
papier biały / white paper druk / print	szaro-bordowy grey-maroon				
	szaro-granatowy grey-dark blue				
	grafitowy graphite	✓			
papier chamois / ivory paper druk / print	szaro-bordowy grey-maroon				
	szaro-granatowy grey-dark blue				
	grafitowy graphite				
papier z recyklingu / recycled paper druk / print	grafitowy graphite				
papier z trawy / grass paper druk / print	grafitowy graphite				
papier z kamienia / stone paper druk / print	grafitowy graphite	✓			
język / language		GB			
dane personalne / personal data		✓			
licznik dni / day counter					
numeracja tygodni / week numbering					
karta planowania celów / goal planning sheet					
święta międzynarodowe / international holidays					
kalendarz skrócony / shortened calendar 2024-2026					
plan urlopowy / vacation plan 2025					
planer roczny / annual planner		✓			
planer miesięczny / monthly planner					
kalendarz roczny / annual calendar 2025		✓			
imieniny / name day					
aforyzmy / aphorisms					
oświadczenie drogowe / road accident statement					
notes / notebook		✓			
mapy / maps					

PLANER / planner		517	REGISTRY / index		perforacja narożników corner perforation
format / format		147 × 203 mm ~A5	drukowane printed	wycinane cut-out	
ilość stron / pages		240			
papier biały / white paper druk / print	szaro-bordowy grey-maroon				
	szaro-granatowy grey-dark blue				
	grafitowy graphite	✓			
papier chamois / ivory paper druk / print	szaro-bordowy grey-maroon				
	szaro-granatowy grey-dark blue				
	grafitowy graphite				
papier z recyklingu / recycled paper druk / print	grafitowy graphite				
papier z trawy / grass paper druk / print	grafitowy graphite				
papier z kamienia / stone paper druk / print	grafitowy graphite				
język / language		PL GB			
dane personalne / personal data		✓			
licznik dni / day counter					
numeracja tygodni / week numbering		✓			
karta planowania celów / goal planning sheet					
święta międzynarodowe / international holidays		✓			
kalendarz skrócony / shortened calendar 2025		✓			
plan urlopowy / vacation plan 2025					
planer roczny / annual planner					
planer miesięczny / monthly planner		✓			
kalendarz roczny / annual calendar 2025					
imieniny / name day					
aforyzmy / aphorisms					
oświadczenie drogowe / road accident statement					
notes / notebook					
mapy / maps					

UKŁADY KALENDARZY BIURKOWYCH / desk calendar layouts

505T

Blank desk calendar layout for the month of Czerwiec (June).

CZERWIEC
June, Juni, Giugno, Июнь

Tydzień 23
Week, Woche, Settimana, Тиждень

2	3	4	5	6	7	8
Poniedziałek Mo / Mo / Lu / Di	Wtorek Tu / Di / Ma / Fr	Środa We / Mi / Me / Cp	Czwartek Th / Do / G / Hr	Piątek Fr / Fr / Ve / Ft	Sobota Sa / Sa / Sa / Cb	Niedziela Su / So / Do / Hn
Enzima, Marianny	Leszka, Kibikły	Karolka, Franciszka	Waleri, Bonifacjo	Pauliny, Norberta	Robert, Wiesława	ZIELONE ŚWIĄTKI Maksyma, Medarda
7	7	7	7	7	7	7
8	8	8	8	8	8	8
9	9	9	9	9	9	9
10	10	10	10	10	10	10
11	11	11	11	11	11	11
12	12	12	12	12	12	12
13	13	13	13	13	13	13
14	14	14	14	14	14	14
15	15	15	15	15	15	15
16	16	16	16	16	16	16

1 | 2 | 3 | 4 | 5 | 6 | 7 | 8 | 9 | 10 | 11 | 12 | 13 | 14 | 15 | 16 | 17 | 18 | 19 | 20 | 21 | 22 | 23 | 24 | 25 | 26 | 27 | 28 | 29 | 30

518T

NEW

Blank desk calendar layout for the month of Luty / February / Marzec / March.

LUTY / FEBRUARY / MARZEC / MARCH 2025

24 PN / MO 25 W / TU 26 ŚR / WE 27 CZ / ŚN 28 PI / FR 1 SO / SA

2 ND / SU

1 2 3 4 5 6 7 8 9 10 11 12 13 14 15 16 17 18 19 20 21 22 23 24 25 26 27 28 29 30 31

G0085

NEW

Blank desk calendar layout for the month of Styczeń / January 2025.

STYCZEŃ 2025 miejsce na logo 75 x 10 mm

poniedziałek wtorek środa czwartek piątek sobota niedziela

30 31 1 2 3 4 5

6 7 8 9 10 11 12

13 14 15 16 17 18 19

20 21 22 23 24 25 26

27

JANUARY 2025 space for a logo 75 x 10 mm

monday tuesday wednesday thursday friday saturday sunday

30 31 1 2 3 4 5

6 7 8 9 10 11 12

13 14 15 16 17 18 19

20 21 22 23 24 25 26

27 28 29 30 31 1 2

KALENDARZ / calendar		505T	518T	G0085	REGISTRY / index		perforacja narożników corner perforation
format / format		297 × 105 mm biurkowy desk	205 × 150 mm biurkowy desk	155 × 133 mm biurkowy desk	drukowane printed	wycinane cut-out	
ilość stron / pages		128	53	12			
papier biały / white paper druk / print	szaro-bordowy grey-maroon						
	szaro-granatowy grey-dark blue						
	grafitowy graphite	✓	✓				
papier chamois / ivory paper druk / print	szaro-bordowy grey-maroon						
	szaro-granatowy grey-dark blue						
	grafitowy graphite						
papier z recyklingu / recycled paper druk / print	grafitowy graphite						
papier z trawy / grass paper druk / print	grafitowy graphite						
papier z kamienia / stone paper druk / print	grafitowy graphite						
karton biały / white cardboard	czarno-zielony black-green lub / or czarno-brązowy black-brown			✓			
układ kalendarza tygodniowego / weekly calendar layout		✓	✓				
język / language		PL GB DE IT UA	PL GB	PL lub / or GB			
dane personalne / personal data		✓					
licznik dni / day counter		✓					
numeracja tygodni / week numbering		✓					
karta planowania celów / goal planning sheet							
święta międzynarodowe / international holidays		✓					
kalendarz skrócony / shortened calendar 2024-2026		✓					
plan urlopowy / vacation plan 2025							
planer roczny / annual planner							
planer miesięczny / monthly planner				✓			
kalendarz roczny / annual calendar 2025			✓				
imieniny / name day		✓					
aforyzmy / aphorisms							
oświadczenie drogowe / road accident statement							
notes / notebook		✓					
mapy / maps							

UKŁADY NOTESOWE / notebook layouts

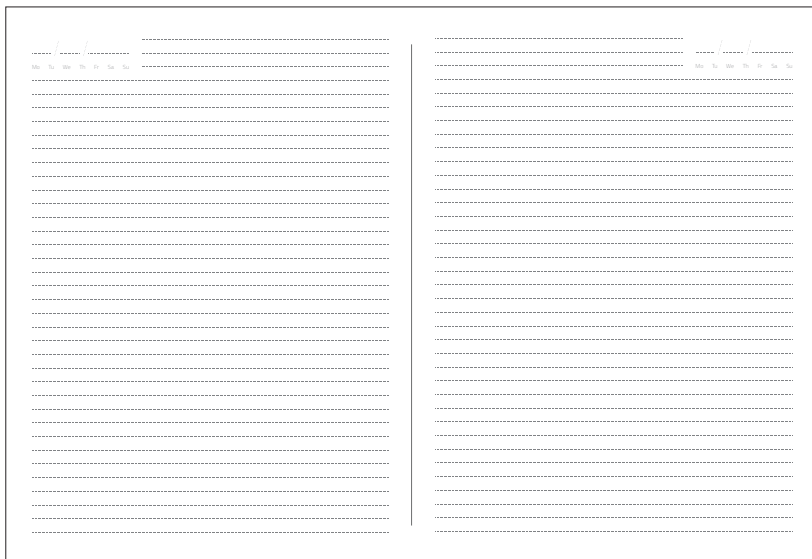

LINIA / line

WERSJA MIĘDZYNARODOWA / international version

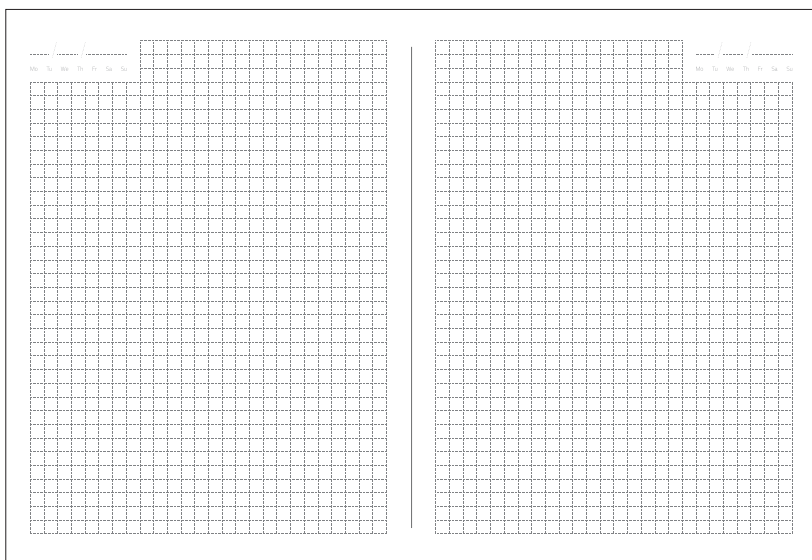

KRATKA / squared

WERSJA MIĘDZYNARODOWA / international version

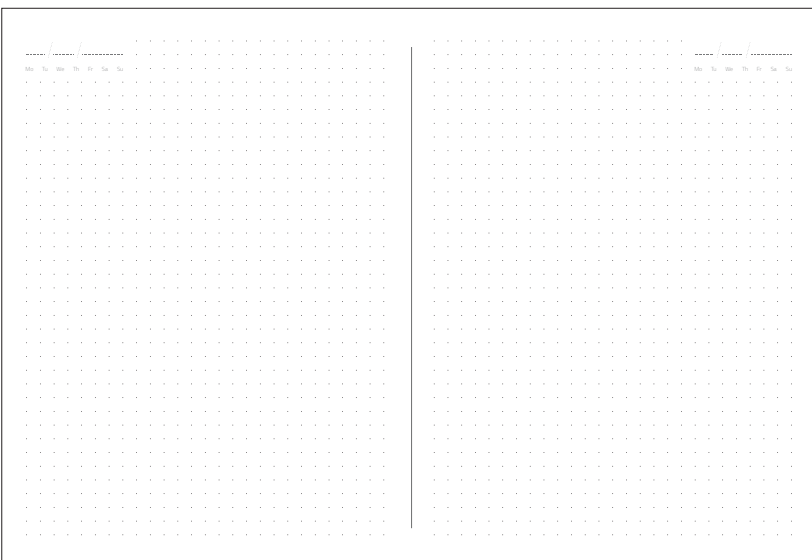

KROPKI / dots

WERSJA MIĘDZYNARODOWA / international version

NOTES / notebook			~A6	~A5	~B5	~A4
format / format			105 × 140 mm	130 × 208 mm	167 × 240 mm	208 × 260 mm
ilość stron / pages			192	192	192	192
papier biały / white paper druk / print	grafitowy / graphite	linia / line	✓	✓	✓	
		kratka / squared	✓	✓	✓	✓
		kropki / dots		✓		
		gładki / plain	✓	✓		
papier chamois / ivory paper druk / print	grafitowy / graphite	linia / line		✓		
		kratka / squared		✓		
		kropki / dots				
		gładki / plain				
perforacja pionowa i pozioma na 16 ostatnich stronach / vertical and horizontal perforation of last 16 pages				✓	✓	✓

ilość stron / pages				192	192	
papier z recyklingu / recycled paper druk / print	grafitowy / graphite	linia / line				
		kratka / squared				
		kropki / dots		✓	✓	
		gładki / plain				
perforacja pionowa i pozioma na 16 ostatnich stronach / vertical and horizontal perforation of last 16 pages						

ilość stron / pages				144	144	
papier z trawy / grass paper druk / print	grafitowy / graphite	linia / line				
		kratka / squared		✓	✓	
		kropki / dots				
		gładki / plain				
perforacja pionowa i pozioma na 16 ostatnich stronach / vertical and horizontal perforation of last 16 pages						

ilość stron / pages				144	144	
papier z kamienia / stone paper druk / print	grafitowy / graphite	linia / line		✓	✓	
		kratka / squared		✓	✓	
		kropki / dots		✓		
		gładki / plain		✓		
perforacja pionowa i pozioma na 16 ostatnich stronach / vertical and horizontal perforation of last 16 pages						

język datownika / date header language	GB NIE DOTYCZY BŁOKÓW NOTESOWYCH GŁADKICH / does not apply to plain layout notebooks				
--	---	--	--	--	--

ZESTAWIENIE BLOKÓW / overview of interior blocks

KALENDARZ DZIENNY / daily calendar

BLOK block	ILOŚĆ STRON number of pages	FORMAT BLOKU block format	PAPIER / paper				PLANER MIESIĘCZNY monthly planner	PERFORACJA NAROŻNA corner perforation	AFORYZMY aphorisms	REGISTRY / index	
			BIAŁY white	CHAMOIS ivory	RECYKLING recycled	DRUK print*				WYCINANE cut-out	DRUKOWANE printed
501D	368	200 × 280 mm	✓	✓		• • • • •	✓	✓	✓	✓	✓
503D	368	143 × 203 mm	✓	✓		• • • • •	✓	✓	✓	✓	✓
503D	368	143 × 203 mm			✓	•		✓			✓
506D	368	110 × 160 mm	✓			•		✓			✓
508D	368	162 × 240 mm	✓	✓		• • • • •	✓	✓	✓	✓	✓
510D	368	143 × 203 mm	✓			•		✓			✓

* • / •• / ••• kolor druku / print colour

KALENDARZ TYGODNIOWY / weekly calendar

BLOK block	ILOŚĆ STRON number of pages	FORMAT BLOKU block format	PAPIER / paper						PLANER MIESIĘCZNY monthly planner	PERFORACJA NAROŻNA corner perforation	AFORYZMY aphorisms	REGISTRY / index	
			BIAŁY white	CHAMOIS ivory	RECYKLING recycled	TRAWA grass	KAMIEŃ stone	DRUK print*				WYCINANE cut-out	DRUKOWANE printed
502T	160	208 × 260 mm	✓	✓					• • • • •	✓	✓	✓	✓
504T	128	84 × 151 mm	✓	✓					•				✓
505T	128	297 × 105 mm	✓						•				
507T	160	167 × 240 mm	✓	✓					• • • • •	✓	✓	✓	✓
					✓			•		✓		✓	✓
509T	160	149 × 203 mm	✓	✓	✓	✓	✓	•		✓			
511T	160	208 × 260 mm	✓			✓	✓	•		✓			
512T	160	167 × 240 mm	✓	✓	✓	✓	✓	•		✓			
514T	160	167 × 240 mm	✓					•		✓			
518T	53	205 × 150 mm	✓					•					

* • / •• / ••• kolor druku / print colour

PLANER DZIENNY Z NOTESEM / daily planner with notebook

BLOK block	ILOŚĆ STRON number of pages	FORMAT BLOKU block format	PAPIER / paper		
			BIAŁY white	KAMIEŃ stone	DRUK print*
516	160	167 × 240 mm	✓	✓	•

* • kolor druku / print colour

PLANER DWUDZIENNY / two-day planner

BLOK block	ILOŚĆ STRON number of pages	FORMAT BLOKU block format	PAPIER / paper		
			BIAŁY white	KAMIEŃ stone	DRUK print*
517	240	147 × 203 mm	✓		•

* • kolor druku / print colour

KALENDARZ MIESIĘCZNY / monthly calendar

BLOK block	ILOŚĆ STRON number of pages	FORMAT BLOKU block format	PAPIER / paper	
			KARTON cartboard	DRUK print*
G0085	12	155 × 133 mm	✓	• • / • • •

* PL ••, EN ••• kolor druku / print colour

NOTES / notebook

BLOK block	ILOŚĆ STRON number of pages	FORMAT BLOKU block format	PAPIER / paper					GŁADKI plain	LINIA line	KRATKA squared	KROPKI dots	PERFORACJA perforation**
			BIAŁY white	CHAMOIS ivory	RECYKLING recycled	TRAWA grass	KAMIEŃ stone					
A6	192	105 × 140 mm	✓					✓	✓	✓		
A5	192	130 × 208 mm	✓					✓	✓	✓	✓	✓
	192	130 × 208 mm		✓					✓	✓	✓	✓
	192	130 × 208 mm			✓						✓	
	144	130 × 208 mm				✓				✓		
	144	130 × 208 mm					✓	•	✓	✓	✓	
B5	192	167 × 240 mm	✓					•	✓	✓		✓
	192	167 × 240 mm			✓			•			✓	
	144	167 × 240 mm				✓		•		✓		
A4	192	208 × 260 mm	✓					•		✓		✓

* • kolor druku / print colour

** perforacja pionowa i pozioma na 16 ostatnich stronach / vertical and horizontal perforation of last 16 pages



GADŻETY WYKONANE Z TROSKĄ O ŚRODOWISKO ZE SŁOMY PSZENICZNEJ W POŁĄCZENIU Z ABS /
eco-conscious gadgets made from wheat straw blend with ABS

GADŻETY

g a d g e t s



GŁOŚNIK BLUETOOTH /
bluetooth speaker
słoma pszenicy + ABS /
wheat straw + ABS

G0009

numer katalogowy / catalogue number

- bluetooth / bluetooth: V 5.0
- głośnik / speaker: 3 W
- bateria / battery: 300 mAh
- mikrofon: prowadzenie rozmów w trybie zestawu głośnomówiącego / microphone: hands free calling
- wymiar / size: 87 × 72 × 40 mm
- metoda znakowania: druk UV / marking method: UV printing
- opakowanie / packaging
wymiar / size: 101 × 75 × 46 mm



POWERBANK / powerbank
słoma pszenicy + ABS /
wheat straw + ABS

G0008

numer katalogowy / catalogue number

- bateria / battery: 5000 mAh
- kabel / cable: micro USB
- wejście / input: DC5V-2.0 A
- wyjście / output: DC5V-2.0 A
- wymiar / size: 94 × 63 × 14 mm
- metoda znakowania: druk UV / marking method: UV printing
- opakowanie / packaging
wymiar / size: 113 × 69 × 20 mm



ŁADOWARKA INDUKCYJNA /
wireless charger
słoma pszenicy + ABS /
wheat straw + ABS

G0012

numer katalogowy / catalogue number

- wejście / input: DC5V-2.0 A
- wyjście / output: 5 W
- HUB 2 × USB
- wymiar / size: 90 × 90 × 9 mm
- metoda znakowania: druk UV / marking method: UV printing
- opakowanie / packaging
wymiar / size: 116 × 95 × 16 mm



ROZGAŁĘŻNIK USB DŁUGI /
long USB charging cable
słoma pszenicy + ABS /
wheat straw + ABS

G0011

numer katalogowy / catalogue number

- wstawka / insert: pszenica / wheat
- złącza / connectors:
wejście / input: USB A/C
wyjście / output: USB Micro/C,
Lightning (iPhone)
- wymiar / size: 1185 × 34 × 9 mm
- metoda znakowania: druk UV (dwustronnie) / marking method: UV print (on both sides)
- opakowanie / packaging*
wymiar / size: 46 × 210 × 17 mm



PODŚWIETLANE LOGO /
illuminated logo

ROZGAŁĘŻNIK USB DŁUGI /
long USB charging cable
słoma pszenicy + ABS /
wheat straw + ABS

G0029

numer katalogowy / catalogue number

- wstawka / insert: biała / white
- światło / light: 00 – białe / white
- złącza / connectors:
wejście / input: USB A/C
wyjście / output: USB Micro/C,
Lightning (iPhone)
- wymiar / size: 1185 × 34 × 9 mm
- metoda znakowania: grawer (jednostronnie) / marking method: engraving (one side only)
- opakowanie / packaging*
wymiar / size: 46 × 210 × 17 mm



ROZGAŁĘŻNIK USB DŁUGI /
long USB charging cable
słoma pszenicy + ABS + bambus /
wheat straw + ABS + bamboo

G0030

numer katalogowy / catalogue number

- wstawka / insert: bambus / bamboo
- złącza / connectors:
wejście / input: USB A/C
wyjście / output: USB Micro/C,
Lightning (iPhone)
- wymiar / size: 1185 × 34 × 9 mm
- metoda znakowania: druk UV (jednostronnie) / marking method: UV print (one side only)
- opakowanie / packaging*
wymiar / size: 46 × 210 × 17 mm

* dostępne opakowania str. 139. / available packaging page139.



ECO BOX 3

ŁADOWARKA INDUKCYJNA **G0012** + POWERBANK **G0008** /
 wireless charger G0012 + powerbank G0008



ECO BOX 4

POWERBANK **G0008** + GŁOŚNIK BLUETOOTH **G0009** /
 powerbank G0008 + bluetooth speaker G0009



ECO BOX 5

ŁADOWARKA INDUKCYJNA **G0012** + GŁOŚNIK BLUETOOTH **G0009** /
 wireless charger G0012 + bluetooth speaker G0009



ECO BOX 8

POWERBANK G0008 + ROZGAŁĘŻNIK USB DŁUGI G0011 /
powerbank G0008 + long USB charging cable G0011



G0008



G0029



G0009



G0011

ECO BOX 7

POWERBANK G0008 + ROZGAŁĘŻNIK USB DŁUGI G0029 /
powerbank G0008 + long USB charging cable G0029

ECO BOX 9

GŁOŚNIK BLUETOOTH G0009 + ROZGAŁĘŻNIK USB DŁUGI G0011 /
bluetooth speaker G0009 + long USB charging cable G0011



ECO SET 4

NOTES A5 lub KALENDARZ 509T, 503D lub 510D + POWERBANK **G0008** + GŁOŚNIK BLUETOOTH **G0009** / A5 notebook or 509T, 503D, 510D calendars + powerbank G0008 + bluetooth speaker G0009

**NOTES A5
lub KALENDARZ
509T, 503D lub 510D**

A5 notebook
or 509T, 503D, 510D
calendars



ECO SET 3

NOTES A5 lub KALENDARZ 509T, 503D lub 510D + POWERBANK **G0008** + ŁADOWARKA INDUKCYJNA **G0012** / A5 notebook or 509T, 503D, 510D calendars + powerbank G0008 + wireless charger G0012

**NOTES A5
lub KALENDARZ
509T, 503D lub 510D**

A5 notebook
or 509T, 503D, 510D
calendars



ECO SET 5

NOTES A5 lub KALENDARZ 509T, 503D lub 510D + ŁADOWARKA INDUKCYJNA **G0012** + GŁOŚNIK BLUETOOTH **G0009** / A5 notebook or 509T, 503D, 510D calendars + wireless charger G0012 + bluetooth speaker G0009



SŁUCHAWKI DOUSZNE / earphones ^{NEW}
bambus + ABS / bamboo + ABS

G0084

numer katalogowy / catalogue number

- typ / type: **bezprzewodowe** / wireless
- bluetooth / bluetooth: **V 5.0**
- wymiar / size: **58 × 22 mm**
- pojemność baterii w każdej słuchawce / battery capacity in each earphone: **30mAh**
- pojemność baterii w etui / battery capacity in case: **230 mAh**
- czas pracy / working time: **3-4 godz. / hour**
- czas ładowania / charging time: **1-2 godz. / hour**
- złącza / connectors: **wejście / input: USB C**
- metoda znakowania: **druk UV / marking method: UV print**
- opakowanie / packaging **wymiar / size: 88 × 134 × 30 mm**



ADAPTER SIECIOWY /

network adapter ^{NEW}

ABS

G0083

numer katalogowy / catalogue number

- wymiar / size: **34 × 34 × 78 mm**
- złącza / connectors: **wejście / input: AC110-240V - 50/60Hz 0,5A**
- wyjście / output: **USB - QC 3.0 - 5C - 3A; USB-C PD 20W - 5V - 3A**
- moc wyjściowa / output power **20W**
- metoda znakowania: **druk UV / marking method: UV print**
- opakowanie / packaging **wymiar / size: 38 × 82 × 38 mm**

PODŚWIETLANE LOGO / illuminated logo

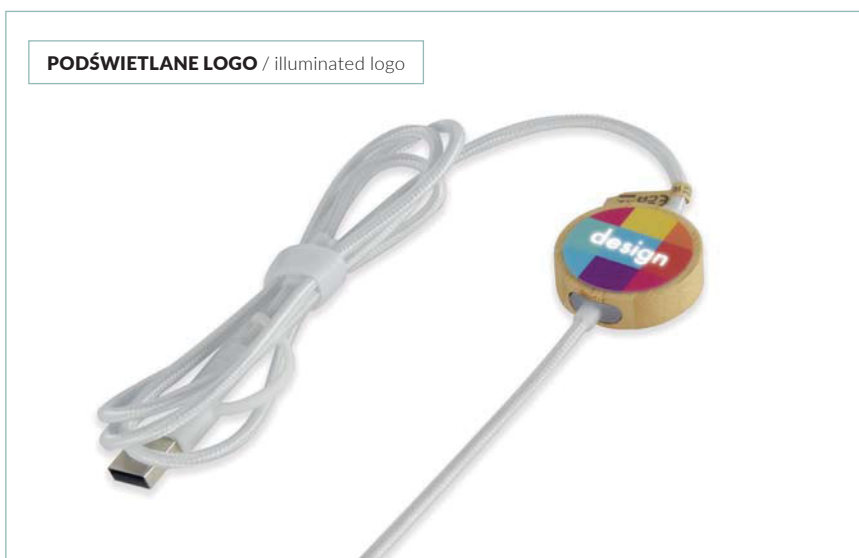

ROZGAŁĘŻNIK USB DŁUGI /

long USB charging cable ^{NEW}

bambus + ABS / bamboo + ABS*

G0082

numer katalogowy / catalogue number

- wstawka / insert: **biała / white**
- światło / light: **00 - białe / white**
- złącza / connectors: **wejście / input: USB A/C**
- wyjście / output: **USB C, Lightning (iPhone)**
- wymiar / size: **1245 × 35 × 10 mm**
- metoda znakowania: **druk UV (jednostronnie) / marking method: UV print (one side only)**
- opakowanie / packaging **wymiar / size: 210 × 46 × 17 mm**



ECO LID NEW

ROZGAŁĘŹNIK USB DŁUGI G0082 + SŁUCHAWKI DOUSZNE G0084 + ADAPTER SIECIOWY G0083 /
long USB charging cable G0082 + earphones G0081 + network adapter G0083

PODŚWIETLANE LOGO / illuminated logo



ROZGAŁĘZNIK USB KRÓTKI /

short USB charging cable
bambus + ABS / bamboo + ABS*

G0032

numer katalogowy / catalogue number

- złącza / connectors:
wejście / input: USB A/C
wyjście / output: USB Micro/C,
Lightning (iPhone)
- wymiar / size: 162 × 37 × 10 mm
- metoda znakowania:
grawer (jednostronnie) /
marking method: engraving
(one side only)
- opakowanie / packaging
wymiar / size: 60 × 170 × 12 mm

PODŚWIETLANE LOGO / illuminated logo



ROZGAŁĘZNIK USB DŁUGI /

long USB charging cable
bambus + ABS / bamboo + ABS*

G0031

numer katalogowy / catalogue number

- wstawka / insert: czarna / black
- światło / light: 00 - białe / white
- złącza / connectors:
wejście / input: USB A/C
wyjście / output: USB C,
Lightning (iPhone)
- wymiar / size: 1220 × 35 × 10 mm
- metoda znakowania:
grawer (jednostronnie) /
marking method:
engraving (one side only)
- opakowanie / packaging
wymiar / size: 86 × 86 × 24 mm



ŁADOWARKA INDUKCYJNA /

wireless charger
bambus / bamboo

G0015

numer katalogowy / catalogue number

- wejście / input: DV5V-2 A
- wyjście / output: 5 W
- wymiar / size: 124 × 98 × 98 mm
- metoda znakowania: druk UV /
marking method: UV printing
- opakowanie / packaging
wymiar / size: 168 × 59 × 120 mm



ECO SET 9

NOTES A5, KALENDARZ 509T, 503D lub 510D + ROZGAŁĘŻNIK USB DŁUGI **G0031** + DŁUGOPIS **G0073** /
A5 notebook, 509T, 503D, 510D calendars + long USB charging cable G0031 + pen G0073



ECO SET 10 NEW

NOTES A5, KALENDARZ 509T, 503D lub 510D + DŁUGOPIS **G0072** + KALENDARZ 504T /
A5 notebook, 509T, 503D or 510D calendars + pen G0072 + 504T calendar

ROZGAŁĘŹNIKI USB / USB charging cables

**DRUK UV
Z PODŚWIETLANYMI
ELEMENTAMI /**
UV print with illuminated
elements



G0067

DRUK UV / UV print



G0067



G0027



G0081



G0068



G0067



OPAKOWANIA STANDARD FOLIOWE Z DRUKOWANYM DWUSTRONNIE KARTONIKIEM WG AUTORSKIEGO PROJEKTU /

foil standard packaging with printed cardboard on both sides
according to customised design

- wymiar / size: 202 × 70 mm

ROZGAŁĘŹNIK USB KRÓTKI / short USB charging cable

G0081 numer katalogowy / catalogue number

- kolor / colour: **granatowy** / navy blue
- światło / light: **00** – białe / white

G0027 numer katalogowy / catalogue number

- kolor / colour: **czerwony** / red
- światło / light: **00** – białe / white

- cztery porty zgodne z / four connectors compatible with: USB, Micro USB, USB C, Lightning (iPhone)
- wymiar / size: 160 × 35 × 10 mm
- metoda znakowania: **grawer (dwustronnie)** / marking method: engraving (on both sides)

G0067 numer katalogowy / catalogue number

- kolor / colour: **biały** / white
- światło / light: **00** – białe / white, **02** – czerwone / red, **03** – pomarańczowe / orange, **07** – niebieskie / blue
- wymiar / size: 153 × 35 × 10 mm

G0068 numer katalogowy / catalogue number

- kolor / colour: **czarny** / black
- światło / light: **00** – białe / white, **02** – czerwone / red, **07** – niebieskie / blue
- wymiar / size: 175 × 35 × 10 mm
- złącza / connectors: wejście / input: USB A/C, wyjście / output: USB Micro/C, Lightning (iPhone)
- metoda znakowania: **grawer (dwustronnie)** / marking method: engraving (on both sides) – **G0067, G0068**
druk UV (dwustronnie) / UV print (on both sides) – **G0067**

POWERBANKI / powerbanks

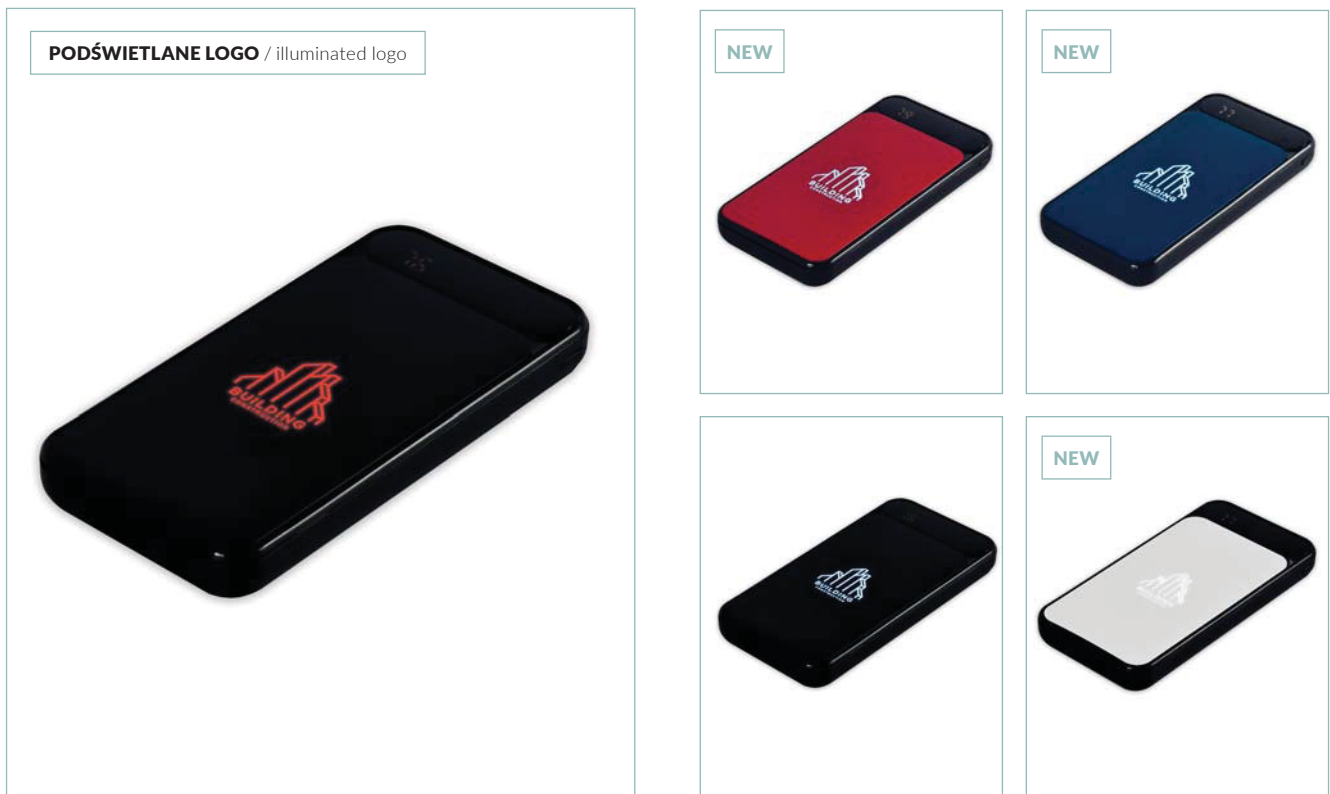

POWERBANK / powerbank

G0074

numer katalogowy / catalogue number

- pojemność baterii / battery capacity: 10 000 mAh
- kolor / colour: **01** - czarny / black, **02** - czerwony / red, **08** - granatowy / navy blue, **00** - biały / white
- światło / light: **00** - białe / white, **02** - czerwone / red, **07** - niebieskie / blue
- wyświetlacz cyfrowy: procent naładowania / digital display: charge percentage
- żywotność: ok. 500 ładowań / number of charging cycles: approx 500
- wejście / input: Micro USB, USB C - DC5V/2A
- wyjścia / output: USB x2 - DC5V/2A (maks. 2,1A)
- wymiar / size: 132,1 × 67 × 20,6 mm
- metoda znakowania: grawer (jednostronnie) / marking method: engraving (one side only)



ROZGAŁĘŻNIKI USB / USB charging cables

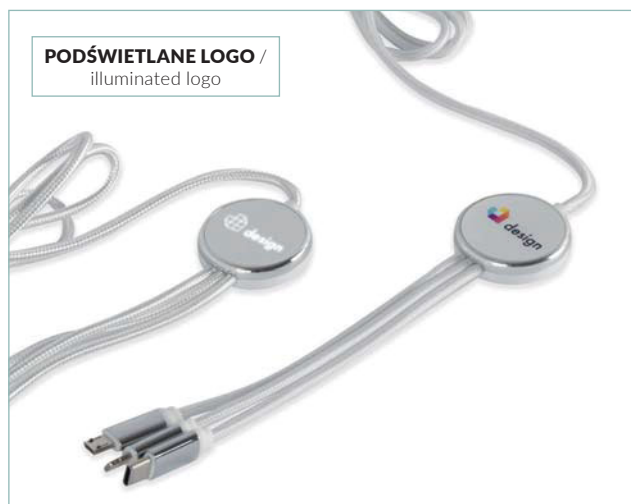

ROZGAŁĘŻNIK USB DŁUGI / long USB charging cable

G0069 numer katalogowy / catalogue number

- kolor / colour: biały / white
- światło / light: 00 - białe / white

G0070 numer katalogowy / catalogue number

- kolor / colour: czarny / black
- światło / light: 00 - białe / white

- złącza / connectors:
wejście / input: USB A/C,
wyjście / output: USB Micro/C, Lightning (iPhone)
- wymiar / size: 1205 × 34 × 9 mm
- metoda znakowania / marking method:
grawer (jednostronnie) / engraving (one side only) - **G0069, G0070**
druk UV (jednostronnie) / UV print (one side only) - **G0069**



SMYCZ WIELOFUNKCYJNA / multifunctional lanyard ^{NEW}

- kabel ładujący 6 w 1 / charging cable 6 in 1:
wejście / input: usb/usb-c, wyjście / output: iphone/usb-c
- transfer danych / data transfer
- materiał: poliester + ABS + metalowy karabińczyk pod identyfikator/kłucze / material: polyester + ABS + metal snap ring for ID/keys

- długość / length: 90 cm
- natężenie / amperage: 2.4 A
- pakowanie / packaging: 54 × 38 × 38 cm
- metoda znakowania / marking method:
druk sublimacyjny (dwustronnie) na smyczy / sublimation print (both sides) on lanyard, druk UV (jednostronnie) na łączniku / UV print (one side) on connector



OPAKOWANIA AUTORSKIE Z WYCIĘCIEM Z PAPIERU BARWIONEGO W MASIE LUB KRAFTOWEGO Z NADRUKIEM CZARNYM /
personalised cut-out packaging made of mass dyed or kraft paper printed in black

- wymiar (rozgałęźnik krótki) / size (short charging cable): 180 × 60 × 20 mm
- wymiar (rozgałęźnik długi) / size (long charging cable): 215 × 70 × 20 mm



OPAKOWANIA AUTORSKIE ZASUWANE Z PAPIERU BARWIONEGO W MASIE Z NADRUKIEM CZARNYM /
personalised mass dyed paper sliding packaging with black print

- ORK0001-01** numer katalogowy / catalogue number
- wymiar (rozgałęźnik krótki) / size (short charging cable): 180 × 53 × 16 mm

- ORD0001-01** numer katalogowy / catalogue number
- wymiar (rozgałęźnik długi) / size (long charging cable): 210 × 60 × 25 mm

POWER SET

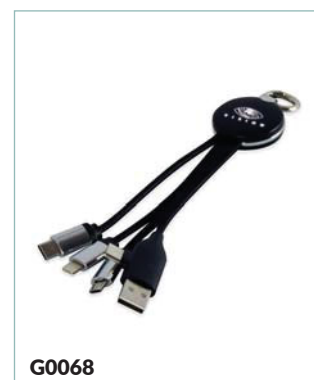

POWERBANK + ROZGAŁĘŹNIK USB KRÓTKI / powerbank + short USB charging cable

kolor zestawu / set colour

opakowanie / packaging

znakowanie opakowania /
marking method on the packaging

czarny / black, granatowy / navy blue, czerwony / red, biały / white

w kolorze zestawu / in the set colour

sitodruk / silk-screen

ENERGY SET

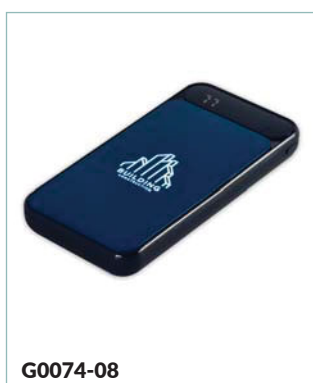
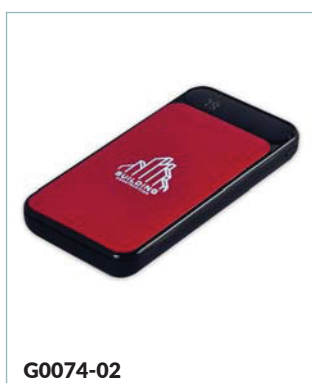

KALENDARZ/NOTES + POWERBANK + ROZGAŁĘŻNIK USB KRÓTKI /
calendar/notebook + powerbank + short USB charging cable

kolor zestawu / set colour

kalendarz lub notes / calendar or notebook

opakowanie / packaging

znakowanie opakowania /
marking method on the packaging

czarny / black, granatowy / navy blue, czerwony / red, biały / white

503D, 509T, 510D – kalendarz / calendar lub / or A5 – notes / notebook

czarny papier barwiony w masie / black mass dyed paper

sitodruk / silk-screen

POWER SET LONG

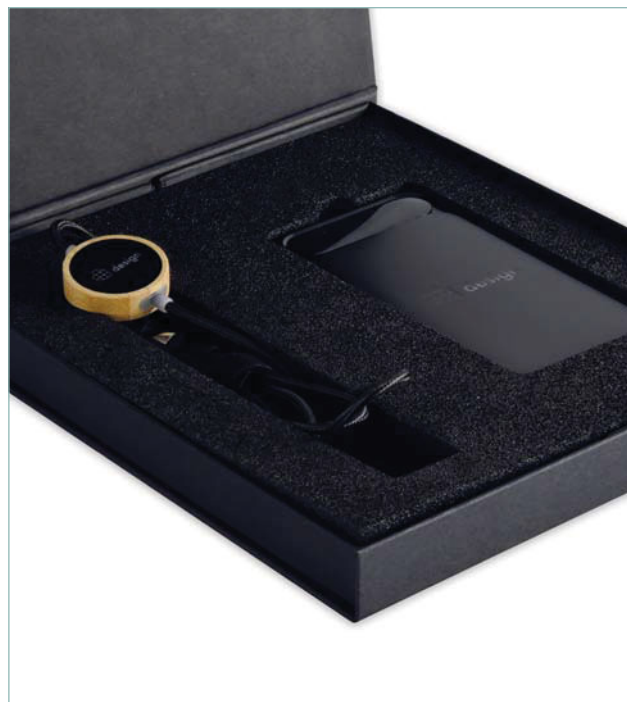

POWERBANK + ROZGAŁĘŹNIK USB DŁUGI / powerbank + long USB charging cable

kolor zestawu / set colour

czarny / black, biały / white

opakowanie / packaging

czarny papier barwiony w masie / black mass dyed paper

znakowanie opakowania /
marking method on the packaging

sitodruk / silk-screen

WHITE BOX & BLACK BOX



NOTES + ROZGAŁĘŹNIK USB KRÓTKI LUB DŁUGI + OZDOBNE PUDEŁKO WIECZKOWE /
notebook + short or long USB charging cable + decorative lid box

kolor zestawu / set colour

czarny / black, biały / white

kalendarz lub notes / calendar or notebook

pod każdy format z wykluczeniem kalendarza 501D i 505T /
for any format except 501D and 505T calendars

kolor rozgałęźnika / charger colour

czarny / black, biały / white

opakowanie / packaging

papier barwiony w masie czarny / black mass dyed paper
karton biały / white cardboard



POWERBANK

G0077-01

numer katalogowy / catalogue number

- pojemność baterii / battery capacity: 10 000 mAh ^{NEW}

G0078-01

numer katalogowy / catalogue number

- pojemność baterii / battery capacity: 20 000 mAh ^{NEW}
- wyświetlacz cyfrowy: procent naładowania / digital display: charge percentage
- szybkie ładowanie / quick charge: 22,5 W
- wejście / input: USB-A, USB-C
- wyjście / output: USB-A, USB-C
- wymiar / size: 144 x 65 x 13 mm
- metoda znakowania: grawer / marking method: engraving
- opakowanie: pudełko czarne / packaging: black box

Ze względu na ograniczenia wynikające z techniki druku, rzeczywiste kolory poszczególnych towarów mogą nieznacznie różnić się od kolorów prezentowanych na zdjęciach. Podane wymiary są wymiarami orientacyjnymi i nie mogą stanowić podstawy reklamacji. Producent zastrzega sobie prawo do technicznych zmian poszczególnych produktów, a także nie ponosi odpowiedzialności za ewentualne błędy w druku. Wszystkie znaki firmowe zamieszczone w katalogu są własnością ich autorów i zaprezentowane są jedynie w celach poglądowych. Katalog nie stanowi oferty w myśl przepisów kodeksu cywilnego. Produkcja w Polsce. / Due to restrictions of printing techniques, actual colours may slightly vary from the ones presented in the catalogue. The sizes and formats provided are for reference only and cannot be the subject of complaint. The manufacturer reserves the right to technical modifications, and is not responsible for any possible printing errors. All the trademarks that appear in the catalogue are the property of their authors and are presented for reference only. The catalogue does not constitute an offer within the meaning of the civil code. Made in Poland.